

# UNIFIED FACILITIES CRITERIA (UFC)

## NAVY ENGINE TEST CELLS



APPROVED FOR PUBLIC RELEASE; DISTRIBUTION UNLIMITED

**UNIFIED FACILITIES CRITERIA (UFC)**

**NAVY ENGINE TEST CELLS**

Any copyrighted material included in this UFC is identified at its point of use. Use of the copyrighted material apart from this UFC must have the permission of the copyright holder.

U.S. ARMY CORPS OF ENGINEERS

NAVAL FACILITIES ENGINEERING COMMAND (Preparing Activity)

AIR FORCE CIVIL ENGINEER SUPPORT AGENCY

Record of Changes (changes are indicated by \1\ ... /1/)

<b>Change No.</b>	<b>Date</b>	<b>Location</b>
1	January 2007	Table 5-1; Paragraph 5-5.2.1.4 and 6-5.7.
2	April 2007	Figure 6-2; Paragraph 6-5.5 and 6-5.7.2.
3	November 2007	Added paragraph 1-6.
4	September 2008	Paragraph 1-6; Table 5-1; Table 6-1; Paragraph 6-4.2; 6-4.3; 6-5; 6--5.7.2; Appendix B.

The Unified Facilities Criteria (UFC) system is prescribed by MIL-STD 3007 and provides planning, design, construction, sustainment, restoration, and modernization criteria, and applies to the Military Departments, the Defense Agencies, and the DoD Field Activities in accordance with [USD\(AT&L\) Memorandum](#) dated 29 May 2002. UFC will be used for all DoD projects and work for other customers where appropriate. All construction outside of the United States is also governed by Status of forces Agreements (SOFA), Host Nation Funded Construction Agreements (HNFA), and in some instances, Bilateral Infrastructure Agreements (BIA.) Therefore, the acquisition team must ensure compliance with the more stringent of the UFC, the SOFA, the HNFA, and the BIA, as applicable.

UFC are living documents and will be periodically reviewed, updated, and made available to users as part of the Services' responsibility for providing technical criteria for military construction. Headquarters, U.S. Army Corps of Engineers (HQUSACE), Naval Facilities Engineering Command (NAVFAC), and Air Force Civil Engineer Support Agency (AFCESA) are responsible for administration of the UFC system. Defense agencies should contact the preparing service for document interpretation and improvements. Technical content of UFC is the responsibility of the cognizant DoD working group. Recommended changes with supporting rationale should be sent to the respective service proponent office by the following electronic form: [Criteria Change Request \(CCR\)](#). The form is also accessible from the Internet sites listed below.

UFC are effective upon issuance and are distributed only in electronic media from the following source:

- Whole Building Design Guide web site <http://dod.wbdg.org/>.

Hard copies of UFC printed from electronic media should be checked against the current electronic version prior to use to ensure that they are current.

AUTHORIZED BY:



DONALD L. BASHAM, P.E.  
Chief, Engineering and Construction  
U.S. Army Corps of Engineers



DR. JAMES W. WRIGHT, P.E.  
Chief Engineer  
Naval Facilities Engineering Command

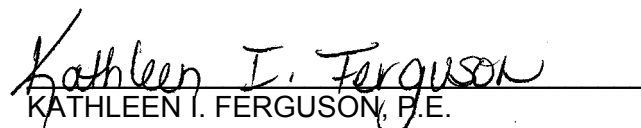

KATHLEEN I. FERGUSON, P.E.  
The Deputy Civil Engineer  
DCS/Installations & Logistics  
Department of the Air Force

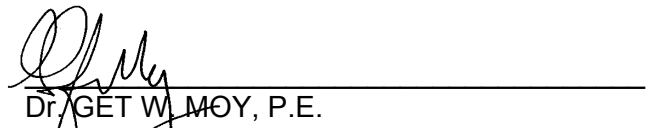

Dr. GET W. MOY, P.E.  
Director, Installations Requirements and  
Management  
Office of the Deputy Under Secretary of Defense  
(Installations and Environment)

**UNIFIED FACILITIES CRITERIA (UFC)  
NEW DOCUMENT AND CHANGE SUMMARY SHEET**

**Document: UFC 4-212-01, Aircraft Engine Test Cells**

\4\

**Description:** This change implements minor editorial changes that have been identified to the preparer since its original publication, especially in Chapters 5 and 6. Concrete testing for airfields with history of poor quality concrete (ASR) has been clarified. The standard drawings are available for download from the CCB database at Whole Building Design Guide (link=[http://www.wbdg.org/ccb/browse\\_cat.php?o=78&c=233](http://www.wbdg.org/ccb/browse_cat.php?o=78&c=233)).

**Reasons for Document:**

- The engine restraint testing procedure and frequency was “out of place” in the airfield pavement design criteria and thus was not mass converted. The new criteria are unique to the Navy engine test cell and NAVAIR engine-testing program.
- Listing of Essential Facility Systems for prioritization of facility maintenance requirements
- The new criteria provide unique facility design criteria essential for the design and construction of a Navy engine test facility. The information will provide a basis of understanding for design engineers and construction surveillance personal in the test cell acquisition process.

**Reason for Changes, September 2008:**

- Add Reference to NAVFAC BMS 15.2.1.
- Added a listing of essential NAVFAC building systems are are essential for the safe operation of the facility. Repairs to these essential facilities shall be done in a timely manner so as to avoid fleet forces costly work “around” procedures and unnecessary down times.
- Coordinate with NAVAIR inspection and testing requirements.
- Clarify airfields with history of poor quality concrete testing requirements.
- Added fire suppression discharge density.

**Impact:** .Safe operation of the facility will be enhanced thru a reliable inspection and preventive maintenance of the fire suppression, engine air start compressor system, and the engine tie down restraints.

**Impact of Changes, September 2008:** Negligible impact to cost. Decrease in conflicts between requirements of different Naval Systems commands.

/4/

**CONTENTS**

CHAPTER 1 INTRODUCTION.....	1
1-1 <b>SCOPE</b> .....	1
1-2 <b>OTHER DESIGN CONSIDERATIONS</b> .....	1
1-2.1 <b>General Building Requirements</b> .....	1
1-2.2 <b>Specific Building Requirements</b> .....	1
1-3 <b>STANDARD DRAWINGS</b> .....	1
1-4 <b>ACOUSTICS</b> .....	2
1-5 <b>TELEPHONE AND OTHER COMMUNICATION SYSTEMS</b> .....	2
1-6 <b>ESSENTIAL FACILITY SYSTEMS FOR JET ENGINE TEST CELLS SAFE OPERATION</b> .....	2
CHAPTER 2 T-10 STANDARD JET ENGINE TEST CELL.....	4
2-1 <b>GENERAL</b> .....	4
2-2 <b>ANTI-TERRORISM/FORCE PROTECTION</b> .....	4
2-3 <b>T-10 SAFETY CLEARANCE</b> .....	4
2-4 <b>LIST OF NAVFAC STANDARD DRAWINGS</b> .....	4
2-5 <b>LIST OF NAVFAC STANDARD SPECIFICATIONS UNIQUE TO JET ENGINE TEST CELLS</b> .....	8
CHAPTER 3 AIRCRAFT ACOUSTICAL ENCLOSURE.....	9
3-1 <b>GENERAL</b> .....	9
3-2 <b>ANTI-TERRORISM/FORCE PROTECTION</b> .....	9
3-3 <b>AIRCRAFT ACOUSTICAL ENCLOSURE SAFETY CLEARANCE</b> .....	9
3-4 <b>LIST OF NAVFAC STANDARD DRAWINGS</b> .....	9
3-5 <b>LIST OF NAVFAC STANDARD SPECIFICATIONS</b> .....	13
CHAPTER 4 OUTDOOR UNABATED POWER CHECK FACILITY.....	15
4-1 <b>GENERAL</b> .....	15
4-2 <b>ANTI-TERRORISM/FORCE PROTECTION</b> .....	15
4-3 <b>OUTDOOR UNABATED POWER CHECK PAD SAFETY CLEARANCE</b> .....	15
4-4 <b>LIST OF NAVFAC STANDARD DRAWINGS</b> .....	15
CHAPTER 5 JET TEST CELL TIE DOWN TESTING REQUIREMENTS.....	17
5-1 <b>PURPOSE</b> .....	17
5-2 <b>BACKGROUND</b> .....	17
5-3 <b>DISCUSSION</b> .....	17
5-4 <b>CRITERIA</b> .....	17
5-5 <b>DESCRIPTION OF SYSTEM</b> .....	18
5-5.1 <b>Special Safety Precautions for Outdoor Unabated Check Pad Proof Test</b> ..	18
5-5.2 <b>Proof Loads</b> .....	19
5-5.3 <b>Inspection and Test Procedures</b> .....	20
5-5.4 <b>Scheduling and Performance Responsibility</b> .....	20
5-5.5 <b>Inspection and Test Results</b> .....	21

5-6	<b>ACTION</b> .....	21
5-6.1	<b>Design</b> .....	21
CHAPTER 6 INSPECTION, TEST PROCEDURES AND RECOMMENDED PROOF TEST ASSEMBLY FOR T-56 TURBO PROP TIE-DOWN FITTINGS..... 29		
6-1	<b>GENERAL</b> .....	29
6-2	<b>DESCRIPTION OF SYSTEM</b> .....	30
6-3	<b>PROOF LOAD TEST ON DIAGAONAL (CORNER) TIE-DOWN PROOF TEST PROCEDURE</b> .....	30
6-3.1	<b>Special Safety Precautions for Proof Test</b> .....	30
6-5	<b>INSPECTION PROCEDURES FOR T-56 TIE-DOWN FITTINGS (ONCE EVERY 5 YEARS)</b> .....	36
6-5	<b>RECOMMENDED PROOF TEST ASSEMBLY(ONCE EVERY 5 YEARS</b> .....	36
APPENDIX A ENGINE TEST CELLSUPPORTING PHOTOGRAPHS OF ENGINE RESTRAINT TEST FITTINGS .....		
		38
APPENDIX B BASIS OF DESIGN.....		
		41
APPENDIX C SAMPLE SUPPORTING STATEMENT TO WAIVER REQUEST.....		
		43
APPENDIX D PROOFLOAD STATEMENT OF CONFORMANCE .....		
		44
APPENDIX E AVIATION TEST FACILITIES, AIRCRAFT AND ENGINE DATA .....		
		45
APPENDIX F REFERENCES.....		
		46

## FIGURES

Figure 5-1	Proof Load Test System for Type XIII & XI-A.....	22
Figure 5-2	Restraint Fitting, Type XI-A, Aircraft Run-p (+ Configuration) .....	25
Figure 5-3	Restraint Fitting Type XI-A, Aircraft Run-up (X Configuration) .....	26
Figure 5-4	Restraint Fitting Type F1, Aircraft Run-up.....	27
Figure 5-5	Restraint Fitting Type F2, Aircraft Run-up.....	27
Figure 5-6	Restraint Fitting Type XIII, Aircraft Run-up .....	28
Figure 6-1	Diagonal Embedment.....	33
Figure 6-2	Diagonal Embedment Pull.....	34
Figure 6-3	Lateral Embedment Pull.....	35
Figure A-2	Examples of Spalling .....	38
Figure A-3	Examples of Map Cracking.....	39
Figure A-3	T-56 Proof Test setup(without Chainfall) .....	39
Figure A-4	Example of Tie Down & NAVAIR ADAPTER RING .....	40
	(DO NOT LOAD TEST WITH THIS ADAPTER RING !)	40
Figure A-5	T-56 Proof Test with Dynamometer, 7.5 ton Chain Fall and 40 Ton Hydraulic Mobile Crane.....	40

**TABLES**

Table 5-1 Inspection and Test Frequency ..... 18

Table 5-2 Jet Engine Test Cell and Unabated Power Check Facility Restraint System  
Proof Loads/Pull Angles ..... 23

Table 5-3 Aircraft Acoustical Enclosure Restraint System Proof Loads/Pull Angles .... 24

Table 6-1 Inspection and Test Frequency - T-56 ..... 29

Table E-1 Aircraft Engine Thrust Data..... 45

## CHAPTER 1 INTRODUCTION

### 1-1           **SCOPE.**

This UFC contains the basic criteria for the design and maintenance of Navy and Marine engine test facilities. Chapter 5 and 6 provide guidance for the testing of aircraft engine tie-downs. Note: Any engine restraint testing performed within the past three years from the publication date of this UFC is recognized to establish the date the next proof test is due.

### 1-2           **OTHER DESIGN CONSIDERATIONS.**

#### 1-2.1       **General Building Requirements.**

General building requirements are in UFC 1-200-01, *General Building Requirements*.

#### 1-2.2       **Specific Building Requirements.**

Closely consult aircraft maintenance officers of shore activities from project definition through the entire design effort of any project related to the construction, repair, or modernization of aircraft organizational and intermediate facilities (refer to Volume 1 of OPNAVINST 4790.2). This ensures that technical requirements for specific aircraft maintenance and testing procedures as outlined in Naval Air (NAVAIR) technical manuals receive proper consideration in the design of these facilities. Specific aircraft data can be obtained from the Aircraft Characteristics Database at <http://www.uscost.net/aircraftcharacteristics/>.

### 1-3           **STANDARD DRAWINGS.**

NAVFAC Standard Jet Engine Test Cell Drawings are considered non-deviational. Specialized knowledge and expertise are required to design, inspect and accept jet engine test cell facilities. NFESC, NAVAIR, and NAVFAC facility engineering commands must jointly provide technical support for the ROICC offices administering aircraft engine test facility contracts. To avoid conflicts, rework, and unauthorized standard design deviations, NFESC, and NAVAIR are designated as the Navy's expert for airflow configuration management and safety. The designer of record and the technical expertise resident within each FEC or EFD supports all routine facility design technical issues. The mission of aircraft engine test facilities dictates that senior level Command personnel review and approve technical matters related to jet engine test cell construction. Deviations made in the field can lead to construction of facilities that will not be accepted and approved for testing of jet engines by NAVAIR. Deviations to facility designs affecting airflow or safety are not encouraged.



**1-4           ACOUSTICS.**

Aircraft engine testing and Base operations have an impact on the type of construction to be used. Generally, jet engine test cell facilities have a design target of limiting noise exposure to less than 85 decibels at 250 feet (76 m).

**1-5           TELEPHONE AND OTHER COMMUNICATION SYSTEMS.**

Coordinate the communications requirements with the activity. For Navy and Marine Corps facilities coordinate with requirements of UFC 3-580-10, *Design: Navy and Marine Corps Intranet Construction Standards*.

\3\

**1-6           ESSENTIAL FACILITY SYSTEMS FOR JET ENGINE TEST CELLS  
SAFE OPERATION.**

The NAVFAC standard test cells are complex to design, build, operate and maintain because they provide similar functions to “on-board” aircraft systems requiring specialized knowledge and expertise. Standard test cells provide engine start-up capability, fuel controls, fire suppression and engine restraints that are essential to the safe operation of the facility. Small engine fires due to fuel and/or oil leaks routinely occur. Navy test cell operators are specially trained to extinguish the small engine fires using the local spurt fire suppression system. Reversing the engine turning direction or “wind milling”, by using the air start compressor, is the next level of protection. Finally, the full water deluge is used to extinguish engine fires. The Standard NAVFAC T-10 drawings are available for download from the CCB database at Whole Building Design Guide (link=[http://www.wbdg.org/ccb/browse\\_cat.php?o=78&c=233](http://www.wbdg.org/ccb/browse_cat.php?o=78&c=233)).

All NAVFAC standard engine test cells rely on foundation tie-downs to restrain and stabilize the engine test trailers and aircraft during final NAVAIR engine test certifications. The design adequacy of the engine restraint system has been well established with over 30 years of proven reliability; however, the inspections and proof tests are the only primary means to ensure the integrity of the foundation concrete and associated embedment hardware.

\4\

The following three NAVFAC systems are critical from a safety and asset risk perspective:

(Refer to NAVFAC BMS B 10 15.2.1 on the NAVFAC portal.)

- Fire suppression system;
- The T-10 sprinkler protection to consist of overhead deluge system having a density

of .35 gpm/ft<sup>2</sup> and a water spray system for the engine and the floor area underneath the trailer having a density of .50 gpm/ft<sup>2</sup>.

**NOTE:** The T-10 fire suppression discharge density shall be verified every 3 years with actual flow tests timed and measured in coordination with the base fire department.

/4/

- Engine air start compressor; and
- Engine tie down restraints (inspection and testing certification procedure, contained herein

/3/

**CHAPTER 2 T-10 STANDARD JET ENGINE TEST CELL**

**2-1 GENERAL.**

When siting the T-10, emphasize operation, function, noise abatement and safety. Other factors to consider include topography, vegetative cover, existing construction, weather elements, wind direction, soil conditions, flood hazards, natural and man-made obstructions, adjacent land use, availability of usable airspace, accessibility of utilities and future expansion capability. Give careful consideration to vehicular parking, pedestrian access and traffic flow.

**2-2 ANTI-TERRORISM/FORCE PROTECTION.**

Use standoff criteria in UFC 4-010-01, *Design: DOD Minimum Antiterrorism Standards for Buildings*.

**2-3 T-10 SAFETY CLEARANCE.**

Orient the T-10 such that it is compliant with all runway safety zone and imaginary surface criteria of NAVFAC P-80.3, *Facility Planning Factor Criteria for Navy/Marine Corps Shore Installations Safety Clearance* and UFC 3-260-01, *Airfield and Heliport Planning and Design*.

**2-4 LIST OF NAVFAC STANDARD DRAWINGS.**

NAVFAC DWG. NO.	DISCIPLINE DWG. NO.	TITLE
		COVER
1405131	T-1	INDEX DRAWING
1405132	A-1	GENERAL NOTES, LEGEND & ABBREVIATIONS
1405133	A-2A	FLOOR PLANS & FINISH SCHEDULE
1405134	A-2B	FLOOR PLANS & FINISH SCHEDULE
1405135	A-3	BUILDING SECTIONS & ELEVATIONS
1405136	A-4	BUILDING ELEVATIONS
1405137	A-5	ANCILLARY BUILDING MISCELLANEOUS PLANS & DETAILS
1405138	A-6	ANCILLARY BUILDING WALL SECTIONS & DETAILS
1405139	A-7	ANCILLARY BUILDING MASONRY & MISCELLANEOUS DETAILS
1405140	A-8	DOOR SCHEDULE & DETAILS
1405141	A-9	MAIN TEST CELL ENTRY DOORS
1405142	A-10	OBSERVATION & VIEW WINDOWS PLANS & DETAILS
1405143	F-1	FOUNDATION PLAN AND SECTIONS
	F-1B	FOUNDATION FOUNDATION PLAN AND SECTIONS (STORED AIR SYSTEM)
1405144	F-2A	AUGMENTER AND EXHAUST DEFLECTOR FOUNDATION PLAN
1405145	F-2B	AUGMENTER AND EXHAUST DEFLECTOR FOUNDATION PLAN
1405146	F-3	FOUNDATION SECTIONS AND DETAILS-1
1405147	F-4	FOUNDATION SECTIONS AND DETAILS-2
1405148	F-5	FOUNDATION SECTIONS AND DETAILS-3
1405149	F-6	FOUNDATION SECTIONS AND DETAILS-4
1405150	F-7A	AIR START RECEIVERS FOUNDATIONS

**UFC 4-212-01N**  
**July 27, 2006**  
**Including Ch 4, September 2008**

NAVFAC DWG. NO.	DISCIPLINE DWG. NO.	TITLE
1405151	F-7B	STORED AIR START COMPRESSOR AND RECEIVERS FOUNDATION
1405152	F-8A	ABOVE GROUND FUEL TANK DIKE STRUCTURE
1405153	F-8B	BELOW GROUND FUEL TANK DIKE STRUCTURE & ANTI- FLOTATION PAD
1405154	SC-1	ANCILLARY BUILDING ROOF PLAN AND SECTIONS
1405155	S-1	TYPICAL BUILDING PANELS SECTIONS AND DETAILS
1405156	S-2	TYPICAL BUILDING SECTIONS AND DETAILS
1405157	S-3	PRIMARY AIR INTAKE PLANS AND SECTIONS
1405158	S-4	PRIMARY AIR INTAKE SECTIONS AND DETAILS-1
1405159	S-5	PRIMARY AIR INTAKE SECTIONS AND DETAILS-2
1405160	S-6	PRIMARY AIR INTAKE TURNING VANES – 1
1405161	S-7	PRIMARY AIR INTAKE TURNING VANES – 2
1405162	S-8	PRIMARY AIR INTAKE TURNING VANE LIFTING MECHANISM & DETAILS
1405163	S-9	PRIMARY AIR INTAKE MISCELLANEOUS TURNING VANE DETAILS
1405164	S-10	PRIMARY AIR INTAKE TURNING VANE CONTROL DIAGRAMS
1405165	S-11	BUILDING PANELS AT VIEW WINDOW
1405166	S-12	BUILDING MISCELLANEOUS SECTIONS AND DETAILS
1405167	S-13	SECONDARY AIR INTAKE PLANS AND SECTIONS
1405168	S-14	SECONDARY AIR INTAKE SECTIONS AND DETAILS – 1
1405169	S-15	SECONDARY AIR INTAKE SECTIONS AND DETAILS – 2
1405170	S-16	SECONDARY AIR INTAKE SECTIONS AND DETAILS – 3
1405171	S-17	AUGMENTER PLAN & SECTIONS
1405172	S-18	AUGMENTER SECTIONS & DETAILS-1
1405173	S-19	AUGMENTER SECTIONS & DETAILS – 2
1405174	S-20	AUGMENTER SECTIONS & DETAILS – 3
1405175	S-21	AUGMENTER SECTIONS & DETAILS-4
1405176	S-22	AUGMENTER SECTIONS & DETAILS -5
1405177	S-23	EXHAUST DEFLECTOR PLAN AND SECTIONS
1405178	S-24	EXHAUST DEFLECTOR AND EXHAUST WALL DETAILS
1405179	S-25	EXHAUST ACOUSTIC WALL PANELS
1405180	S-26	MISCELLANEOUS STEEL AND ACOUSTIC WALL PENETRATIONS
1405181	S-27	PRIMARY & SECONDARY AIR INTAKE PLATFORMS
1405182	S-28	EXHAUST DEFLECTOR PLATFORM
1405183	S-29	INSTRUMENTATION BOOM SECTIONS AND DETAILS
1405184	S-30	TYPE XIII TIE DOWN DECK FITTINGS
	S-30B	STRUCTURAL TYPE IXA TIE DOWN DECK FITTINGS
1405185	S-31	TYPE XIII PROOF TEST SYSTEM – 1
	S-31B	TYPE X1-A PROOF TEST SYSTEM – 1
1405186	S-32	TYPE XIII PROOF TEST SYSTEM – 2
1405187	S-33	ABOVE GROUND FUEL TANK SUPERSTRUCTURE
1405188	M-1	GENERAL NOTES, LEGEND AND ABBREVIATIONS
1405189	M-2A	PLUMBING PLAN AND DETAILS
1405190	M-2B	PLUMBING PLAN & DETAILS
1405191	M-2C	PLUMBING PLAN & DETAILS
1405192	M-2D	PLUMBING PLAN & DETAILS
1405193	M-3A	PLUMBING RISER DIAGRAM & DETAILS
1405194	M-3B	PLUMBING RISER DIAGRAM & DETAILS
1405195	M-4	OIL/WATER SEPARATOR & WASTE PUMP STATION
1405196	M-5A	COMPRESSED AIR SCHEMATIC & DETAILS

**UFC 4-212-01N**  
**July 27, 2006**  
**Including Ch 4, September 2008**

NAVFAC DWG. NO.	DISCIPLINE DWG. NO.	TITLE
1405197	M-5B	COMPRESSED AIR SCHEMATIC & DETAILS
1405198	M-6	COMPRESSED AIR PIPING DETAILS
1405199	M-7A	COMPRESSED AIR DETAILS
1405200	M-7B	COMPRESSED AIR DETAILS
1405201	M-8A	FUEL SYSTEM SCHEMATIC
1405202	M-8B	FUEL SYSTEM SCHEMATIC
1405203	M-9	FUEL & PRESERVATION OIL ROOMS PLAN & SECTIONS
1405204	M-10	FUEL & PRESERVATION OIL ROOMS SECTIONS AND DETAILS
1405205	M-11A	FUEL TANK PLAN, SECTIONS & DETAILS
1405206	M-11B	FUEL TANK PLAN, SECTIONS AND DETAILS
1405207	M-12A	FIRE PROTECTION SYSTEM
1405208	M-12B	FIRE PROTECTION SYSTEM
1405209	M-13A	FIRE PROTECTION SCHEMATIC & SECTIONS
1405210	M-13B	FIRE PROTECTION SCHEMATIC & SECTIONS
1405211	M-14	HVAC PLAN, SCHEDULES AND DETAILS
1405212	E-1	GENERAL NOTES, LEGEND AND ABBREVIATIONS
1405213	E-2	LIGHTING PLAN AND SECTIONS
1405214	E-3A	POWER PLAN
1405215	E-3B	POWER PLAN
1405216	E-3C	POWER PLAN
1405217	E-3D	POWER PLAN
1405218	E-4A	GROUNDING PLAN
1405219	E-4B	GROUNDING PLAN
1405220	E-5	MECHANICAL EQUIPMENT ROOM ELEVATIONS AND SECTIONS
1405221	E-6	ONE LINE DIAGRAM & PANEL SCHEDULES
1405222	E-7	CONTROL DIAGRAMS
1405223	E-8	FIRE ALARM AND TELEPHONE
1405224	E-9A	FUEL TANK
1405225	E-9B	FUEL TANK
1405226	E-10A	LIGHTING FIXTURES
1405227	E-10B	LIGHTING FIXTURES
1405228	I-1A	INSTRUMENTATION PLAN
1405229	I-1B	INSTRUMENTATION PLAN
1405230	I-2	INSTRUMENTATION CONTROL & MECHANICAL ROOMS: PART PLANS & DETAILS
1405231	I-3	INSTRUMENTATION MISCELLANEOUS DETAILS
1405232	I-4	INSTRUMENTATION FACILITIES CONSOLE DETAILS – 1
1405233	I-5	INSTRUMENTATION FACILITIES CONSOLE DETAILS – 2
1405234	I-6	INSTRUMENTATION AIR START CHASSIS
1405235	I-7	INSTRUMENTATION LIGHTING CONTROL CHASSIS
1405236	I-8	INSTRUMENTATION 28 VOLT DISTRIBUTION CHASSIS & CAB POWER CHASSIS
1405237	I-9	INSTRUMENTATION FIRE PROTECTION CHASSIS
1405238	I-10	INSTRUMENTATION FUEL/PRESERVATION OIL CHASSIS – 1
1405239	I-11	INSTRUMENTATION FUEL/PRESERVATION OIL CHASSIS – 2
1405240	I-12	INSTRUMENTATION FUEL/PRESERVATION OIL CHASSIS – 3
1405241	I-13A	INSTRUMENTATION STATUS/ALARM SCHEMATIC
1405242	I-13B	INSTRUMENTATION STATUS/ALARM SCHEMATIC
1405243	I-14A	INSTRUMENTATION STATUS / ALARM ANNUNCIATOR PANEL
1405244	I-14B	INSTRUMENTATION STATUS / ALARM ANNUNCIATOR PANEL
1405245	I-15	INTERCONNECT WIRING SCHEDULE
1405246	I-16	INSTRUMENTATION LADDER-CONTROL DIAGRAMS AND DEVICE

**UFC 4-212-01N**  
**July 27, 2006**  
**Including Ch 4, September 2008**

NAVFAC DWG. NO.	DISCIPLINE DWG. NO.	SCHEDULE	TITLE
--------------------	------------------------	----------	-------

---

2-5            **LIST OF NAVFAC STANDARD SPECIFICATIONS UNIQUE TO  
JET ENGINE TEST CELLS.**

DIVISION 05 – METALS

Section 05500 – Metal Fabrications

DIVISION 08 – DOOR AND WINDOWS

Section 08385 – Sound Reduction Doors  
08500 – Sound Reduction View Windows

DIVISION 09 – FINISHES

Section 09510 – Vinyl Covered Acoustical Wall System

DIVISION 10 – SPECIALTIES

Section 10200 – Proof Load Test Aircraft/Engine Restraint

DIVISION 13 – SPECIAL CONSTRUCTION

Section 13100 – Engine Test Enclosure, Primary and Secondary Air Intakes  
13200 – Augmenter, Exhaust Deflector and Exhaust Acoustical Wall  
Panels  
13300 – Turning Vane Assembly

DIVISION 14 – CONVEYING SYSTEMS

Section 14622 – Monorails with Electric Powered Hoists

DIVISION 15 – MECHANICAL

Section 15355 – Fire Protection System  
15410 – Plumbing, Waste Pump Station and Oil/Water Separator  
15490 – Compressed Air Systems  
15500 – Fire Protection  
15609 – Jet Fuel and Preservation Oil Systems  
15653 – Heating, Ventilating and Air Conditioning

DIVISION 16 – ELECTRICAL

Section 16700 – Instrumentation  
16722 – Fire Detection and Alarm System

## CHAPTER 3 AIRCRAFT ACOUSTICAL ENCLOSURE

### 3-1 GENERAL.

When siting the Aircraft Acoustical Enclosure, emphasize operation, function, noise abatement and safety. Also consider topography, vegetative cover, existing construction, weather elements, wind direction, soil conditions, flood hazards, natural and man-made obstructions, adjacent land use, availability of usable airspace, accessibility of utilities and future expansion capability. Carefully consider vehicular parking, pedestrian access and traffic flow.

### 3-2 ANTI-TERRORISM/FORCE PROTECTION.

Use standoff criteria in UFC 4-010-01.

### 3-3 AIRCRAFT ACOUSTICAL ENCLOSURE SAFETY CLEARANCE.

Orient the aircraft acoustical enclosure so that it is compliant with all runway safety zone and imaginary surface criteria of NAVFAC P-80.3 and UFC 3-260-01.

### 3-4 LIST OF NAVFAC STANDARD DRAWINGS.

NAVFAC DWG. NO.	DISCIPLINE DWG. NO.	TITLE
		COVER
1404940	T-1	INDEX OF DRAWINGS
1404941	A-1	GENERAL NOTES, LEGEND AND ABBREVIATIONS
1404942	A-2A	FLOOR PLAN AND FINISH SCHEDULE
1404943	A-2B	FLOOR PLAN AND FINISH SCHEDULE
1404944	A-2C	FLOOR PLAN AND FINISH SCHEDULE
1404945	A-2D	FLOOR PLAN AND FINISH SCHEDULE
1404946	A-2E	FLOOR PLAN AND FINISH SCHEDULE
1404947	A-2F	FLOOR PLAN AND FINISH SCHEDULE
1404948	A-3	ANCILLARY BUILDING PLAN, SECTIONS AND DETAILS
1404949	A-4A	LONGITUDINAL BUILDING ELEVATIONS
1405123	A-4B	LONGITUDINAL BUILDING ELEVATIONS
1404950	A-5A	TRANSVERSE BUILDING ELEVATIONS
1404951	A-5B	TRANSVERSE BUILDING ELEVATIONS
1404952	A-6	BUILDING SECTIONS
1404953	A-7	ANCILLARY BUILDING SECTIONS AND DETAILS
1404954	A-8	OBSERVATION ROOM SOUND REDUCTION VIEW WINDOWS
1404955	A-9	I & C CONTROL CAB SOUND REDUCTION VIEW WINDOW AND CAB BOOT
1404956	A-10	DOOR SCHEDULE AND DETAILS
1404957	A-11	ACOUSTICAL INTAKE DOOR PLAN AND DETAILS
1404958	A-12	ACOUSTICAL INTAKE DOOR SECTIONS AND DETAILS – 1
1404959	A-13	ACOUSTICAL INTAKE DOOR SECTIONS AND DETAILS-2
1404960	A-14	ACOUSTICAL INTAKE DOOR SECTIONS AND DETAILS-3
1404961	A-15	ACOUSTICAL INTAKE DOOR SECTIONS AND DETAILS-4



**UFC 4-212-01N**  
**July 27, 2006**  
**Including Ch 4, September 2008**

NAVFAC DWG. NO.	DISCIPLINE DWG. NO.	TITLE
1404962	A16	ACOUSTICAL INTAKE DOOR SECTIONS AND DETAILS – 5
1404963	A-17	ACOUSTICAL INTAKE DOOR DOOR BASE FRAMING PLAN
1404964	A-18	ACOUSTICAL INTAKE DOOR BASE SECTIONS AND DETAILS -1
1404965	A-19	ACOUSTICAL INTAKE DOOR BASE SECTIONS AND DETAILS -2
1404966	A-20	ACOUSTICAL INTAKE DOOR BASE SECTIONS AND DETAILS -3
1404967	A-21	ACOUSTICAL INTAKE DOOR RAIN CAP INTAKE SCREEN
1404968	A-22	ACOUSTICAL INTAKE DOOR WIND LOCKS
1404969	A-23	ACOUSTICAL INTAKE DOOR CONTROL DIAGRAMS
1404970	A-24	MASONRY AND MISCELLANEOUS DETAILS
1404971	A-25	MECHANICAL/ELECTRICAL DISCONNECT BOXES ACOUSTICAL ENCLOSURE
1404972	F-1	BUILDING FOUNDATION PLAN AND NOTES
	F-2A	AUGMENTER AND EXHAUST DEFLECTOR FOUNDATION PLAN (AIR RECEIVERS AND FUTURE T23/T14)
1404974	F-2B	AUGMENTER AND EXHAUST DEFLECTOR FOUNDATION PLAN
1404975	F-2C	AUGMENTER AND EXHAUST DEFLECTOR FOUNDATION PLAN
1404976	F-2D	AUGMENTER AND EXHAUST DEFLECTOR FOUNDATION PLAN
1404977	F-2E	AUGMENTER AND EXHAUST DEFLECTOR FOUNDATION PLAN
1404978	F-2F	AUGMENTER AND EXHAUST DEFLECTOR FOUNDATION PLAN
1404979	F-3	FOUNDATION SECTIONS AND DETAILS-1
1404980	F-4	FOUNDATIONS SECTIONS AND DETAILS-2
1404981	F-5	FOUNDATIONS SECTION AND DETAILS – 3
1404982	F-6	FOUNDATION SECTIONS AND DETAILS – 4
1404983	F-7	FOUNDATION SECTIONS AND DETAILS – 5
1404984	F-8	FOUNDATION SECTIONS AND DETAILS – 6
1404985	F-9	FOUNDATION SECTIONS AND DETAILS-7
1404986	F-10A	AIR START RECEIVERS FOUNDATIONS
1404987	F-10B	STORED AIR START COMPRESSOR AND RECEIVERS FOUNDATION
1404988	F-11A	A/E37T-23 FUEL/PRESERVATION OIL SYSTEM PADS AND DIKES
1404989	F-11B	A/E37T-14 FUEL/PRESERVATION OIL SYSTEM PADS AND DIKES
1404990	F-12	A/E37T-14/T-23 FUEL/PRESERVATION OIL SYSTEM PADS AND DIKE DETAILS
1404991	SC-1	ANCILLARY BUILDING ROOF PLAN AND BUILDING DETAILS
1404992	S-1	TYPICAL BUILDING PANELS SECTIONS AND DETAILS – 1
1404993	S-2	TYPICAL BUILDING PANELS SECTIONS AND DETAILS – 2
1404994	S-3	TYPICAL BUILDING PANELS SECTIONS AND DETAILS – 3
1404995	S-4	TYPICAL BUILDING PANELS SECTIONS AND DETAILS-4
1404996	S-5	TYPICAL BUILDING PANELS SECTIONS AND DETAILS – 5
1404997	S-6	AUGMENTER PLAN AND SECTIONS
1404998	S-7	AUGMENTER SECTIONS AND DETAILS – 1
1404999	S-8	AUGMENTER SECTIONS AND DETAILS – 2
1405000	S-9	AUGMENTER SECTIONS AND DETAILS – 3
1405001	S-10	AUGMENTER SECTIONS & DETAILS-4
1405002	S-11	AUGMENTER SECTIONS AND DETAILS – 5
1405003	S-12	TYPICAL AUGMENTER LINER SHEET AND DETAILS
1405004	S-13	EXHAUST DEFLECTOR PLAN AND SECTIONS
1405005	S-14	EXHAUST DEFLECTOR SECTIONS AND DETAILS-1
1405006	S-15	EXHAUST DEFLECTOR SECTIONS AND DETAILS – 2
1405007	S-16	EXHAUST DEFLECTOR PLATFORM
1405008	S-17	WINCH ASSEMBLY DETAILS
1405009	S-18	NOSEGEAR ELEVATOR PLATFORM GENERAL ARRANGEMENT

**UFC 4-212-01N**  
**July 27, 2006**  
**Including Ch 4, September 2008**

NAVFAC DWG. NO.	DISCIPLINE DWG. NO.	TITLE
1405010	S-19	NOSEGEAR ELEVATOR PLATFORM DETAILS AND SCHEMATICS
1405011	S-20	RESTRAINT FITTINGS
1405012	S-21	WHEEL CHOCK ASSEMBLY
1405013	S-22	WHEEL CHOCK ASSEMBLY DETAILS-1
1405014	S-23	WHEEL CHOCK ASSEMBLY DETAILS – 2
1405015	S-24	AIRCRAFT RESTRAINT TEST SYSTEM TIE-DOWN FITTINGS & PLATFORM
1405016	S-25	AIRCRAFT RESTRAINT SYSTEM WHEEL CHOCK ASSEMBLY
1405017	S-26	ENGINE TRAILER RESTRAINT TEST SYSTEM
1405018	S-27	RESTRAINT TEST SYSTEM COMPONENTS
1405019	S-28	SPOTTING DOLLY GENERAL ARRANGEMENT
1405020	S-29	SPOTTING DOLLY DETAILS
1405021	S-30	MECHANICAL/ELECTRICAL DISCONNECT BOXES STRUCTURAL FRAMED OPENINGS
1405022	S-31	INSTRUMENTATION SWING BOOM
1405023	M-1	MECHANICAL GENERAL NOTES, LEGEND AND ABBREVIATIONS
1405024	M-2A	PLUMBING PLAN
1405025	M-2B	PLUMBING PLAN
1405026	M-2C	PLUMBING PLAN
1405027	M-2D	PLUMBING PLAN
1405028	M-2E	PLUMBING PLALN
1405029	M-2F	PLUMBING PLAN
1405030	M-3A	PLUMBING PART PLAN AND DETAILS
1405031	M-3B	PLUMBING PART PLAN AND DETAILS
1405032	M-4A	PLUMBING DETAILS AND RISER DIAGRAMS
1405033	M-4B	PLUMBING DETAILS AND RISER DIAGRAMS
1405034	M-5	INDUSTRIAL WASTE PUMP STATION AND OIL/WATER SEPARATOR
1405035	M-6A	COMPRESSED AIR SCHEMATIC & DETAILS
1405036	M-6B	COMPRESSED AIR SCHEMATIC & DETAILS
1405037	M-7	AIR START SYSTEM DETAILS
1405038	M-8A	LOW PRESSURE AIR START RECEIVERS
1405039	M-8B	HIGH PRESSURE STORED AIR START COMPRESSOR AND RECEIVERS
1405040	M-9A	FIRE PROTECTION
1405041	M-9B	FIRE PROTECTION
1405042	M-9C	FIRE PROTECTION
1405043	M-9D	FIRE PROTECTION
1405044	M-10	HVAC
HHM-11	M-11	PRESERVATION OIL SKID SCHEMATIC, AND GENERAL NOTES
1405045	M-11A	PRESERVATION OIL SYSTEM AND A/E37T-23 FUEL SYSTEM SCHEMATIC AND NOTES
1405046	M-11B	PRESERVATION OIL SYSTEM AND A/E37T-14 SYSTEM SCHEMATIC AND NOTES
1405047	M-12	PRESERVATION OIL SYSTEM PRESERVATION OIL SKID GENERAL ARRANGEMENT
1405048	M-13	PRESERVATION OIL SYSTEM PRESERVATION OIL SKID DETAILS
HHM-14	M-14	FUEL / PRESERVATION OIL PIPE MANIFOLD & FUEL HOSES
1405049	M-14A	PRESERVATION OIL SYSTEM PIPE MANIFOLD AND HOSES
1405050	M-14B	PRESERVATION OIL SYSTEM PIPE MANIFOLD AND HOSES
1405051	M-15	PRESERVATION OIL SYSTEM SKID CONTROL CABINET

**UFC 4-212-01N**  
**July 27, 2006**  
**Including Ch 4, September 2008**

NAVFAC DWG. NO.	DISCIPLINE DWG. NO.	TITLE
1405052	M-16	PRESERVATION OIL SYSTEM SKID CONTROL CABINET WIRING DIAGRAM
1405053	M-17	PRESERVATION OIL SYSTEM CONTROL SCHEMATIC DIAGRAMS
1405054	E-1	ELECTRICAL GENERAL NOTES, LEGEND AND ABBREVIATIONS
1405055	E-2A	LIGHTING PLAN AND DETAILS
1405056	E-2B	LIGHTING PLAN AND DETAILS
1405057	E-2C	LIGHTING PLAN AND DETAILS
1405058	E-3A	POWER PLAN AND DETAILS
1405059	E-3B	POWER PLAN AND DETAILS
1405060	E-3C	POWER PLAN AND DETAILS
1405061	E-3D	POWER PLAN AND DETAILS
1405062	E-3E	POWER PLAN AND DETAILS
1405063	E-3F	POWER PLAN AND DETAILS
1405064	E-4A	GROUNDING PLAN AND DETAILS
1405065	E-4B	GROUNDING PLAN AND DETAILS
1405066	E-4C	GROUNDING PLAN AND DETAILS
1405067	E-4D	GROUNDING PLAN AND DETAILS
1405068	E-4E	GROUNDING PLAN AND DETAILS
1405069	E-4F	GROUNDING PLAN AND DETAILS
1405070	E-5	ELEVATIONS AND DETAILS
1405071	E-6A	ONE LINE DIAGRAM, SCHEDULES AND SCHEMATICS
1405072	E-6B	ONE LINE DIAGRAM, SCHEDULES AND SCHEMATICS
1405073	E-7A	FIRE ALARM SYSTEM
1405074	E-7B	FIRE ALARM SYSTEM
1405075	E-8	LIGHTING FIXTURE DETAILS
1405076	I-1A	INSTRUMENTATION PLAN AND DETAILS
1405077	I-1B	INSTRUMENTATION PLAN AND DETAILS
1405078	I-1C	INSTRUMENTATION PLAN AND DETAILS
1405079	I-1D	INSTRUMENTATION PLAN AND DETAILS
1405080	I-1E	INSTRUMENTATION PLAN AND DETAILS
1405081	I-1F	INSTRUMENTATION PLAN AND DETAILS
1405082	I-2	INSTRUMENTATION CONSOLE AND INSTRUMENT CABINET
1405083	I-3	INSTRUMENTATION PRESSURE TRANSMITTER CHASSIS
1405084	I-4A	INSTRUMENTATION ANALOG DATA ACQUISITION SYSTEM & ALARM CHASSIS
1405085	I-4B	INSTRUMENTATION ANALOG DATA ACQUISITION SYSTEM & ALARM CHASSIS
1405086	I-5	INSTRUMENTATION LIGHTING CONTROL CHASSIS
1405087	I-6	INSTRUMENTATION 28 VOLT DISTRIBUTION CHASSIS
1405088	I-7A	INSTRUMENTATION DOOR CONTROL CHASSIS
1405088	I-7B	INSTRUMENTATION DOOR CONTROL CHASSIS
1405090	I-8	INSTRUMENTATION AFFF FIRE CONTROL CHASSIS
1405091	I-9A	INSTRUMENTATION AIR START CHASSIS
1405092	I-9B	INSTRUMENTATION AIR START CHASSIS
1405093	I-10A	INSTRUMENTATION CCTV SYSTEM
1405094	I-10B	INSTRUMENTATION CCTV SYSTEM
1405095	I-11	INSTRUMENTATION INSTRUMENT TERMINAL CABINET
1405096	I-12	INSTRUMENTATION A/E37T-14/T-23 FIRE CONTROL CHASSIS
1405097	I-13	INSTRUMENTATION PRESERVATION OIL SYSTEM CAB CONTROL CHASSIS
1405098	I-14	A/E37T-14/T-23 INSTRUMENTATION PRESERVATION OIL

NAVFAC DWG. NO.	DISCIPLINE DWG. NO.	TITLE
		SYSTEM CONTROL WIRING DIAGRAM
1405099	I-15	INSTRUMENTATION A/E37T-14/T-23 CABLE-1
1405100	I-16	INSTRUMENTATION A/E37T-14/T-23 CABLE-2
1405101	I-17	INSTRUMENTATION A/E37T-14/T-23 CABLE-3
1405102	I-18	INSTRUMENTATION A/E37T-14/T-23 CABLE-4
1405103	I-19	INSTRUMENTATION A/E37T-14/T-23 CABLE-5
1405104	I-20	INSTRUMENTATION A/E37T-14/T-23 CABLE-6
1405105	I-21	INSTRUMENTATION A/E37T-14/T-23 CABLE-7
1405106	I-22	INSTRUMENTATION A/E37T-14/T-23 CABLE-8
1405107	I-23	INSTRUMENTATION A/E37T-14/T-23 CABLES-9, 10, 11 & 12
1405108	I-24	INSTRUMENTATION A/E37T-14/T-23 CABLES-13, 14, 15 & 16
1405109	I-25	INSTRUMENTATION A/E37T-14/T-23 CABLE-17
1405110	I-26	INSTRUMENTATION A/E37T-14/T-23 CABLE-18
1405111	I-27	INSTRUMENTATION A/E37T-14/T-23 CABLE-19
1405112	I-28	INSTRUMENTATION A/E37T-14/T-23 CABLE-20
1405113	I-29	INSTRUMENTATION A/E37T-14/T-23 CABLE-21
1405114	I-30	INSTRUMENTATION A/E37T-14/T-23 CABLE-22
1405115	I-31	INSTRUMENTATION A/E37T-14/T-23 CABLE-23
1405116	I-32	INSTRUMENTATION A/E37T-14/T-23 CABLE-24
1405117	I-33	INSTRUMENTATION A/E37T-14/T-23 CABLE-25
1405118	I-34	INSTRUMENTATION A/E37T-14/T-23 CABLE-27
1405119	I-35	INSTRUMENTATION A/E37T-14/T-23 HOSES (HARNESS ASSEMBLY)
1405120	I-36	INSTRUMENTATION A/E37T-14/T-23 CONTROLEX CABLES
1405121	I-37	INSTRUMENTATION A/E37T-14/T-23 CAB INTERFACE CABLES
1405122	I-38	INSTRUMENTATION A/E37T-14/T-23 WIREWAY & CABLE TRAY
1405123	I-39	INSTRUMENTATION A/E37T-14/T-23 ANNUNCIATOR LAMP CABINET

**3-5 LIST OF NAVFAC STANDARD SPECIFICATIONS.**

**DIVISION 05 – METALS**

Section 05500 – Metal Fabrications

**DIVISION 08 – DOORS AND WINDOWS**

Section 08385 – Sound Reduction Personnel Doors  
08500 – Sound Reduction Windows

**DIVISION 10 – SPECIALTIES**

Section 10200 – Proof Load Test Aircraft/Engine Restraint

**DIVISION 13 – SPECIAL CONSTRUCTION**

Section 13100 – Prefabricated Aircraft Test Enclosure

13200 – Augmenter, Exhaust Deflector and Exhaust Wall Panels  
13300 – Acoustical Intake Sliding Doors

**DIVISION 14 – CONVEYING SYSTEMS**

Section 14100 – Aircraft Tow Winch  
14200 – Nosegear Elevator Platform

**DIVISION 15 – MECHANICAL**

Section 15355 – Fire Protection System  
15410 – Plumbing, Waste Pump Station and Oil/Water Separator  
15487 – A/E37T-23 Fuel and Preservation Oil Systems  
15490 – Compressed Air Systems  
15653 – Heating, Ventilating and Air Conditioning

**DIVISION 16 – ELECTRICAL**

Section 16268 – 400-Hertz (HZ) Solid State Frequency Converter  
16700 – Instrumentation  
16710 – Structured Telecommunications Cabling and Pathway System  
16722 – Fire Alarm and Fire Detection System

## CHAPTER 4 OUTDOOR UNABATED POWER CHECK FACILITY

### 4-1 GENERAL.

When siting the out door unabated power check facility, emphasize operation, function, noise abatement and safety. Also consider topography, vegetative cover, existing construction, weather elements, wind direction, soil conditions, flood hazards, natural and man-made obstructions, adjacent land use, availability of usable airspace, accessibility of utilities and future expansion capability. Carefully consider vehicular parking, pedestrian access and traffic flow.

### 4-2 ANTI-TERRORISM/FORCE PROTECTION.

Use standoff criteria in UFC 4-010-01.

### 4-3 OUTDOOR UNABATED POWER CHECK PAD SAFETY CLEARANCE.

Orient the outdoor unabated power check facility so that it is compliant with all runway safety zone and imaginary surface criteria of NAVFAC P-80.3 and UFC 3-260-01.

### 4-4 LIST OF NAVFAC STANDARD DRAWINGS.

NAVFAC DWG. NO.	DISCIPLINE DWG. NO.	TITLE
10400153	T-01	COVER SHEET AND DRAWING LIST
10400154	S-01	TURBOFAN / JET ENGINE POWER CHECK PADS GENERAL ARRANGEMENT
10400155	S-02	TURBOFAN / JET AIRCRAFT POWER CHECK PAD DETAILS
10400156	S-03	TURBOFAN / JET ENGINE OUT OF-AIRFRAME T-23 POWER CHECK PAD DETAILS
10400157	S-04	V/STOL AIRCRAFT POWER CHECK PAD GENERAL ARRANGEMENT PLAN SECTIONS AND DETAILS
10400158	S-05	V/STOL AIRCRAFT POWER CHECK PAD GRATING PART PLAN, DETAILS AND SECTIONS
10400159	S-06	V/STOL AIRCRAFT POWER CHECK PAD VANE DETAILS – 1
10400160	S-07	V/STOL AIRCRAFT POWER CHECK PAD VANE DETAILS – 2
10400161	S-08	V/STOL AIRCRAFT POWER CHECK PAD FOUNDATION PLAN, SECTIONS AND DETAILS
10400162	S-09	V/STOL AIRCRAFT POWER CHECK PAD FOUNDATION DETAILS
10400163	S-10	V/STOL AIRCRAFT POWER CHECK PAD RAMP DETAILS
10400164	S-11	V/STOL AIRCRAFT PWER CHECK PAD REFRACTORY PLAN, SECTIONS AND DETAILS
10400165	S-12	TYPICAL DETAILS-1
10400166	S-13	TYPICAL DETAILS – 2
10400167	S-14	TURBOFAN / JET PWER CHECK PAD BLAST DEFLECTOR DETAILS
10400168	S-15	PROOF LOAD TEST RESTRAINT FITTINGS-1
10400169	S-16	PROOF LOAD TEST TESTRAIN FITTINGS-2

**UFC 4-212-01N**  
**July 27, 2006**  
**Including Ch 4, September 2008**

NAVFAC DWG. NO.	DISCIPLINE DWG. NO.	TITLE
10400170	S-17	PROOF LOAD TEST RESTRAINTS FITTINGS AND TEST COMPONENTS
10400171	S-18	V/STOL AIRCRAFT POWER CHECK PAD FENCE AND GROUNDING DETAILS
10400172	S-19	T-56 / T-76 POWER CHECK PADS GENERAL ARRANGEMENT AND DETAILS
10400173	S-20	T-56 / T-76 POWER CHECK PADS BLAST DEFLECTOR DETAILS
10400174	S-21	T-56 /T-76 PROOF LOAD TEST RESTRAINTS FITTINGS AND TEST COMPONENTS-SHEET 1
10400175	S-22	T-56 /T-76 PROOF LOAD TEST RESTRAINTS FITTINGS AND TEST COMPONENTS-SHEET 2
10400176	S-23	T-56 /T-76 PROOF LOAD TEST RESTRAINTS FITTINGS AND TEST COMPONENTS-SHEET 3

CHAPTER 5 JET TEST CELL TIE DOWN TESTING REQUIREMENTS

5-1 **PURPOSE.**

This chapter provides basic criteria and information for the testing of Navy/Marine Corps aircraft and engine restraints used in Jet Engine Test Cells, Unabated Power Check Facilities, and Aircraft Acoustical Enclosures.

5-2 **BACKGROUND.**

The restraint fitting designs have been in the fleet inventory for 20+ years and the design adequacy has proven itself. The frequency of testing identified in Figure 5-1 has been revised to reflect the confidence that Navy/Marine aircraft engine testing personnel have developed in the type XIII hardware. The XIII fitting has proven to very reliable and, thus, a reduced amount of proof load testing is appropriate. The XIA fitting is adequate; however, does not offer the same margin of safety that the type XIII fitting, and, thus, the original test frequency of an annual proof test is still valid.

5-3 **DISCUSSION.**

The Navy's current shore facilities maintenance program encourages prudent expenditure of facility maintenance dollars. The NAVFAC aviation facilities engineering program is dedicated to providing criteria that reflect user functional requirements as well as optimizing return on investment. Safety is always the highest priority.

5-4 **CRITERIA.**

Use the following guidance for inspection and testing to determine that all component parts of a land-based aircraft and engine restraint system are in a safe and properly maintained operating condition.

Naval Air Station activities regularly engaged in aircraft engine overhaul shall inspect and proof test their aircraft engine restraints to the frequency shown in Table 5-1 and 6-1.



**Table 5-1 Inspection and Test Frequency**

Note: The system consists of a restraint fitting (Type XIII, XI-A, etc.) fastened to a steel embedment anchored in the concrete foundation. Load test the system at the following intervals:

<b>Requirement</b>	<b>Type XIII</b>	<b>Type XI-A</b>
Initial Installation	Load test new installations prior to operational use	Load test new installations prior to operational use
Certification renewal	Inspect and load test every 5 years	Inspect and load test \1\ every three (3) years. /1/
After repair and/or replacement of any of the components (i.e., restraint fittings, bolts, etc.)	Load test repaired assembly prior to operational use	Load test repaired assembly prior to operational use
Visual Signs of deterioration	Prior to each operational use	Prior to each operational use
<p><b>NOTE:</b> Due to ongoing problems with alkali-silica deterioration, the recommended minimum test frequency for engine restraints is three years at the following airfields: NAS Point Mugu, CA; NAS Fallon, NV; NOLF San Nicolas Island, CA; MCAS Iwakuni, Japan; MCAS Cherry Point, NC; NAS Whidbey Island, WA; and MCAF Quantico, VA. The frequency can be reset to the standard frequency once inspection determines there is no alkali-silica reaction present at the test cells.</p>		

**NOTE:** In lieu of the three-year load test for airfields with a history of poor quality concrete, concrete cores can be taken to ensure that alkali-silica is not present. Core tests will extend the frequency of testing for type XIII to once every five years.

**5-5 DESCRIPTION OF SYSTEM.**

The proof load system (encl (1) generally consists of a hydraulic system for applying the load, which includes a hand pump and a single acting pull cylinder; special structural fixtures which interface with the proof load test fitting; and a chain assembly, turnbuckle and hardware to interface with the restraint fitting to be tested.

**5-5.1 Special Safety Precautions for Outdoor Unabated Check Pad Proof Test.** (Unless the chain fall and the dynamometer in Figure A-5 are used to feather in the applied load)

5-5.1.1 Barricade or rope off the area around tie down fittings. Secure area size of 50 feet by 100 feet minimum.

5-5.1.2 Provide secondary restraints to proof load system using a 1-inch (25-mm) diameter nylon rope secured to adjacent tie downs. Nylon rope to be a minimum length of 50 feet and is to be secured to proof test load system in a

slack condition; absorbing load only in the event of an unanticipated release of the primary tie down fittings.

NOTE: For T-10 and Hush House applications, the run room is to be secured as if an actual engine test were being conducted.

5-5.2           **Proof Loads.** Restraint fitting proofloads with the corresponding pull angles are indicated in the following Table 5-1.

5-5.2.1        Ensure the proof load tests for Jet Engine Test Cells and Unabated Power Check Facility restraint systems are in accordance with Table 5-1. Use test procedures that gradually increase the load in increments as follows:

5-5.2.1.1      Single XI-A (“+” configuration-Proof-test load= 30,000 lbs.

- 10,000 lbs. Hold for one minute
- 20,000 lbs. Hold for one minute
- 25,000 lbs. Hold for one minute
- 30,000 lbs. Hold for ten minutes

5-5.2.1.2      Single XI-A (“x” configuration-Proof-test load= 45,000 lbs.

- 10,000 lbs. Hold for one minute
- 30,000 lbs. Hold for one minute
- 40,000 lbs. Hold for one minute
- 45,000 lbs. Hold for ten minutes

5-5.2.1.3      Dual XI-A (“x” or “+” configuration- and Dual Type XIII Proof-test load= 60,000 lbs.

- 10,000 lbs. Hold for one minute
- 30,000 lbs. Hold for one minute
- 40,000 lbs. Hold for one minute
- 50,000 lbs. Hold for one minute
- 60,000 lbs. Hold for ten minutes

5-5.2.1.4      Single XIII Proof-test load= 90,000 lbs.

- 20,000 lbs. Hold for one minute
- 45,000 lbs. Hold for one minute
- 70,000 lbs. Hold for one minute
- 90,000 lbs. Hold for ten minutes
- \1\ (Deleted incorrect step.) /1/

5-5.2.2 Ensure the proof test load for Aircraft Acoustical Enclosure (Hush House) restraint systems is in accordance with Chapter 6. Use test procedures that gradually increase the load in increments as follows:

5-5.2.2.1 Dual XIII Proof-test load= 60,000 lbs.

- 10,000 lbs. Hold for one minute
- 30,000 lbs. Hold for one minute
- 40,000 lbs. Hold for one minute
- 50,000 lbs. Hold for one minute
- 60,000 lbs. Hold for ten minutes

### 5-5.3 **Inspection and Test Procedures.**

5-5.3.1 Induce tension in the chain assembly by slowly pumping the hydraulic hand pump until the assembly is taut. When the load is applied, keep personnel clear of the immediate test area.

5-5.3.2 Increase the load gradually in increments. After each load increment and when the final proof load is reached, close and hold the hydraulic safety valve. Remotely observe the restraint system during the loading phases. If any indication of cracking or deformation is apparent, gradually release the load and terminate the test.

5-5.3.3 After the loading phase is completed and the load released, inspect the restraint system components (fittings, bolts, anchor base and concrete in the immediate area) for signs of distress. Replace fittings and anchors showing such distress.

### 5-5.4 **Scheduling and Performance Responsibility.**

Scheduling of inspections and tests is the responsibility of the AIMD Power plants officer or his designated representative tasked with overseeing the daily operation of the test facility. Inspection and tests must be made by qualified personnel familiar with inspection and certification of load handling devices. Qualified personnel shall be regularly engaged with weight testing, heavy industrial rigging applications, or be approved by the NAVFAC Criteria Program.

**5-5.5 Inspection and Test Results.**

5-5.5.1 Promptly initiate necessary action to correct discrepancies found during inspections and tests.

5-5.5.2 Furnish a copy of the deficiencies found and the required corrective action to NAVAIR Lakehurst, code 4.8.6.8 and to NAVFAC Atlantic, Special Assistant for Aviation Facilities.

If deficiencies are found by the inspection, report to the AIMD (Aircraft Intermediate Maintenance Department) power plants officer or a representative of the NAVAIR AETS (Aircraft Engine Test System) team for resolution.

**5-6 ACTION.**

**5-6.1 Design.**

Design all new jet engine test facility, unabated power check pads, and aircraft acoustical enclosures using the guidance for the above-mentioned Aircraft and Engine System proof Load Test Requirements.

In the future, inspect and certify the jet engine test facility, unabated power check pads, and aircraft acoustical Aircraft and Engine System fittings in accordance with the requirements of this UFC.

Figure 5-1 Proof Load Test System for Type XIII & XI-A

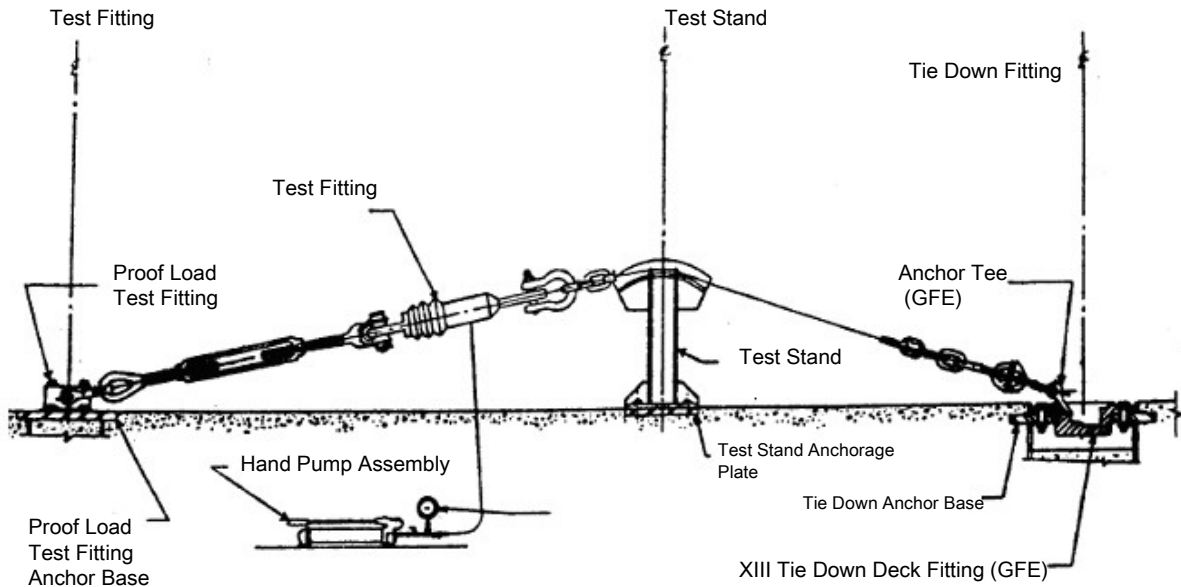

**Table 5-2 Jet Engine Test Cell and Unabated Power Check Facility  
 Restraint System Proof Loads/Pull Angles**

Restraint Fitting(s) Type	Maximum Safe Working Load (Pounds)	In-Service Usage	Proof Test – Load (Pounds)	Proof-Test – Angle (Degrees)	Notes
Single XI-A (“+”) Configuration	15,000	In-airframe Run-up and/or Out of Airframe Engine Run-up	30,000	15	(1)
Single XI-A (“x”) Configuration	22,500	In-airframe Run-up and/or Out of Airframe Engine Run-up	45,000	15	(2)
Dual XI-A (“x” or “+”) Configuration	30,000	Out of Airframe Engine Run-up	60,000	30	(3)
Single F2	22,500	In-airframe Run-up and/or Out of Airframe Engine Run-up	45,000	15	(2)
Dual F2	30,000	Out of Airframe Engine Run-up	60,000	30	(3)
Single XIII	45,000	In-airframe Run-up and/or Out of Airframe Engine Run-up	90,000	15	(4)
Dual XIII	30,000	Out of Airframe Engine Run-up	60,000	30	(3)
Single F1	45,000	In-airframe Run-up	90,000	15	(4)
<b>NOTES:</b>					
(1) A 30,000 pound proof-load-test of a single, “+” configured Type XI-A fitting certifies a site for a maximum safe working load of 15,000 pounds. Simultaneous, dual-engine, maximum testing (military and/or afterburner) is prohibited for all aircraft. All aircraft and engine testing exceeding 15,000 pounds of thrust is also prohibited.					
(2) A 45,000 proof-load-test of a single fitting certifies a site to test all aircraft (except F-14A+/D) and all engines (except F110-GE-400). This does not include simultaneous, dual engine afterburner testing of F-4, F-14A and F/A-18 aircraft.					
(3) A 60,000 pound proof-load-test on a dual set of fittings certifies a site to test all engines.					
(4) A 90,000 pound proof-load-test on a single fitting certified a site to test all aircraft (excluding simultaneous, dual-engine afterburner testing of F-14A+/D aircraft) and all engines.					

**Table 5-3 Aircraft Acoustical Enclosure Restraint System Proof Loads/Pull Angles**

Restraint Fittings Type	Maximum Safe Working Load (Pounds)	In-Service Usage	Proof Test – Load (Pounds)	Proof Test – Angle (Degrees)	Note
Single XIII	45,000	In-Airframe Run-up	90,000	15	(1)
Single F1	30,000	In-Airframe Run-up	60,000	15	(1)
Hybrid	30,000	In-Airframe Run-up	60,000	15	(1) & (2)
Dual XIII	30,000	Out-of-Airframe Run-up	60,000	15	
NOTES:					
(1) Simultaneous, Dual-engine, afterburner testing is prohibited for all aircraft.					
(2) Applies to non-standard fittings at NAS Patuxent River, MD and NAS Jacksonville, FL.					

Figure 5-2 Restraint Fitting, Type XI-A, Aircraft Run-p (+ Configuration)

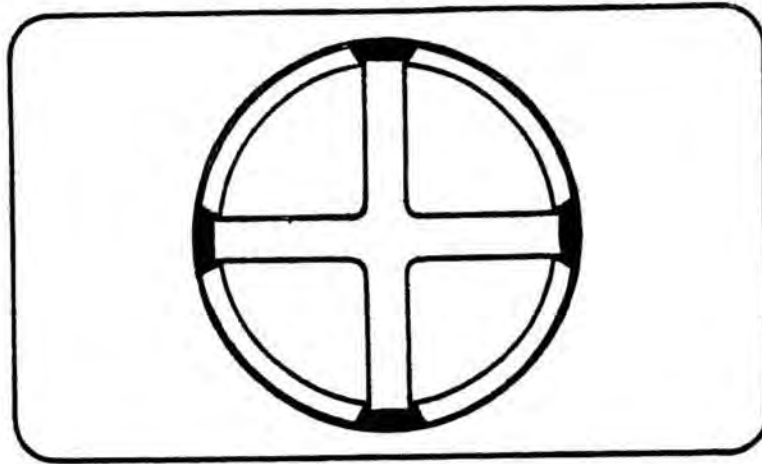

WELDED

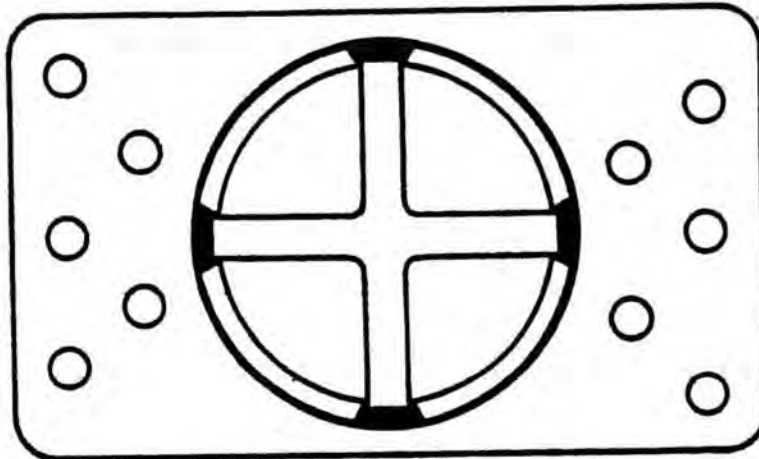

BOLTED



Figure 5-3 Restraint Fitting Type XI-A, Aircraft Run-up (X Configuration)

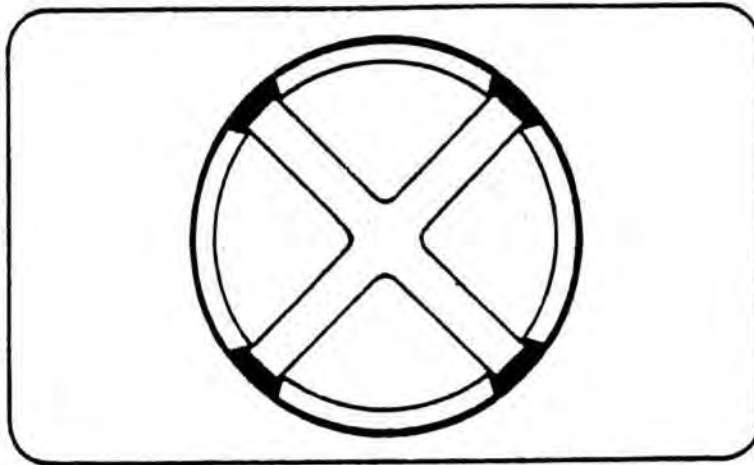

WELDED

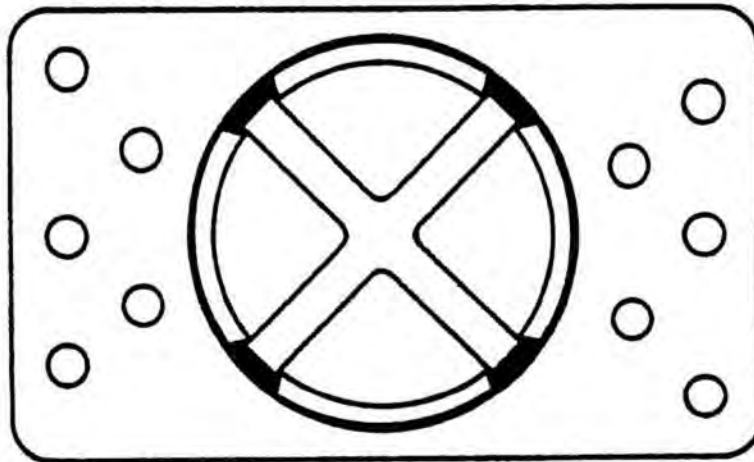

BOLTED

Figure 5-4 Restraint Fitting Type F1, Aircraft Run-up

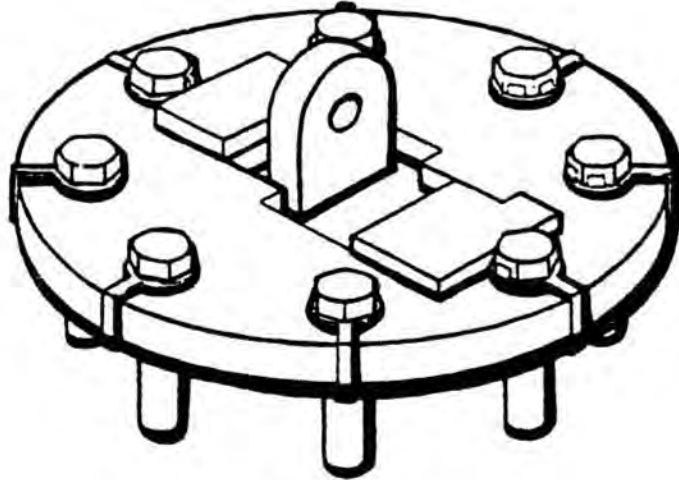

Figure 5-5 Restraint Fitting Type F2, Aircraft Run-up

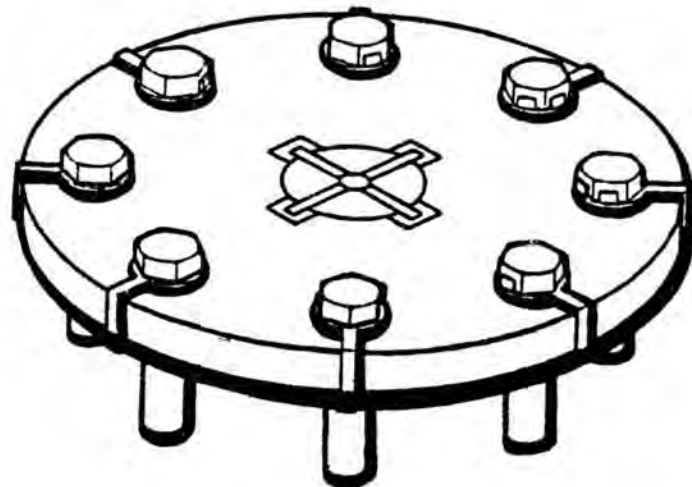
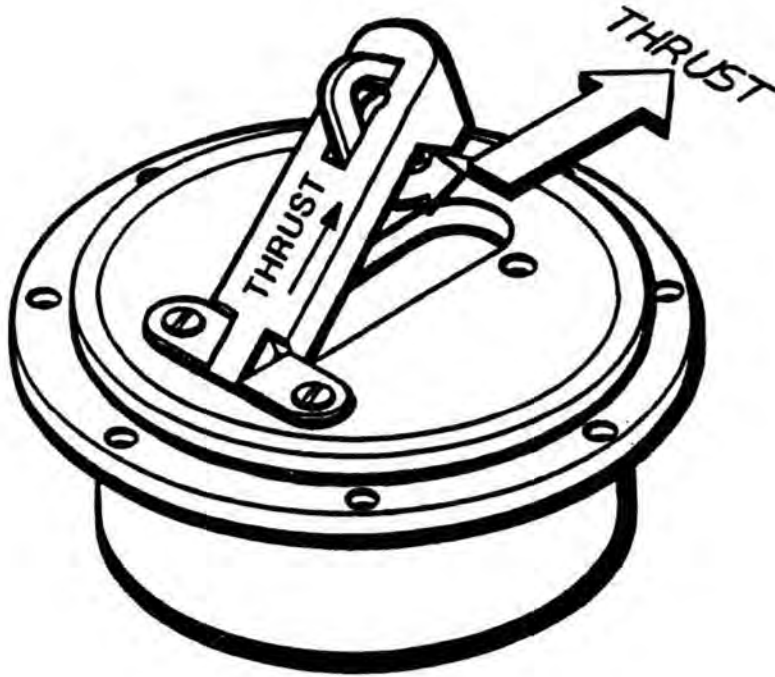

Figure 5-6 Restraint Fitting Type XIII, Aircraft Run-up



**CHAPTER 6 INSPECTION, TEST PROCEDURES AND RECOMMENDED PROOF TEST ASSEMBLY FOR T-56 TURBO PROP TIE-DOWN FITTINGS**

**6-1 GENERAL.**

The purpose of the proof load test system is to permit an initial and subsequent structural integrity test of T-56 Tie-down Fittings.

**Table 6-1 Inspection and Test Frequency - T-56**

NOTE: The system consists of a restraint fitting (T-56) anchored to the concrete foundation. Load test the system at the following intervals:

\4\

Requirement	T-56
Initial installation	Load test new installations prior to operational use.
Certification renewal	Inspect and load test every 5 years.
After repair and/or replacement of any of the components (i.e., restraint fittings, bolts, etc.)	Load test repaired assembly prior to operational use.
Visual signs of deterioration	Prior to each operational use: <ul style="list-style-type: none"> <li>□ Inspect concrete within a 2 ft-0 in (0.6 m) radius of tie downs for new (since most recent proof test) signs of deterioration, cracking or spalling. See Figures C-10 and C-11 for typical spalling and chemical deterioration of concrete (map cracking that is indicative of Alkali-Silica reaction presence in concrete.) When in doubt, use a 12 oz hammer and tap the concrete surface. Good concrete has a sharp, clear ring; badly deteriorated concrete has a dull thud.</li> <li>□ Inspect steel mooring eye for signs of excessive corrosion or pitting. Report losses in cross sectional diameter greater than 5% of original "as-built" condition. NAVFAC standard drawings call for mooring eye to 1-in (25-mm) diameter.</li> </ul>
NOTE: Due to ongoing problems with alkali-silica deterioration, the recommended minimum test frequency for engine restraints is three years at the following airfields: NAS Point Mugu, CA; NAS Fallon, NV; NOLF San Nicolas Island, CA; MCAS Iwakuni, Japan; MCAS Beaufort, SC; MCAS Cherry Point, NC; NAS Whidbey Island, WA; and MCAF Quantico, VA. The frequency can be reset to the standard frequency once inspection determines there is no alkali-silica reaction present at the test cells.	

/4/

## 6-2 DESCRIPTION OF SYSTEM.

For testing T-56 fittings embedded in outdoor unabated power check pads constructed prior to September 30th, 2006, use the proof loading system as shown in Fig 6-2 to generally consist of a mobile crane hydraulic system, shackles, turnbuckle, and cable, special structural fixtures to interface with the restraint fittings; and chain and hardware. For T-56 fittings embedded in outdoor unabated power check pads constructed after September 30th, 2006, use the proof loading system similar to Fig 5-1 that has been specially modified for T-56 layout geometry to generally consists of a hydraulic jacking system, shackles, turnbuckle, and cable, special structural fixtures to interface with the restraint fittings; and chain and hardware

6.2.1 No proof load test is required for the side restraints(non-load bearing, stabilizers) when using the T-10 modified hydraulic jacking system(similar to Fig. 5-1) for T-56 test pads constructed afterheat 30<sup>th</sup>, 2006.

6-3 **Proof Load Test on Diagonal (Corner) Tie-Down Proof test procedure.** The following is a general test procedure for proof loading the tie-down ring.

### 6-3.1 Special Safety Precautions for Proof Test.

6-3.1.1 Barricade or rope off test area around tie down fittings. Secure test area size of 50 feet by 70 feet minimum.

6-3.1.2 Provide secondary restraints to proof load system using a 1-inch (25-mm) diameter nylon rope secured to adjacent tie downs. Nylon rope to be a minimum length of 25 feet and is to be secured to proof test load system in a slack condition; absorbing load only in the event of an unanticipated release of the primary tie down fittings.

6-3.2 Connect a chain assembly and shackle to the hold down ring to be tested. A hydraulic pump, jack stand (similar to on in Figure 5-1) and measuring system could be set up by the test engineer that is suitable to apply the loads described. Apply load (T) at an angle of 30 degrees from the ground surface, shown in Figure 6-1. Use crane overload prevention equipment(certified dynamometer) as shown in Figure 6-2 and 6-3.

### 6-3.3 Diagonal Tie-Down Proof Test Procedure

- a. Locate the centerpoint of the diagonal pad eyes using a steel measuring tape to locate pick point for lifting device.
- b. Install dynamometer and associated rigging in accordance with Figure 6-2.
- c. Check and adjust chain assembly to ensure 30-degree angle is maintained. Use turnbuckle to adjust as necessary.
- d. Apply proof load as described in paragraph 6-3.4.

e. Inspect assembly, engine restraint fittings, and surrounding concrete pavement for signs of distress.

6-3.4 Slowly induce tension in chain assembly. Increase load in increments as specified in a. through e. below:

a. 1,250 pound tension; hold one minute. Record initial and final readings from load indicating device.

b. 3,750 pound tension; hold one minute. Record initial and final readings from load indicating device.

c. 7,500 pound tension; hold one minute. Record initial and final readings from load indicating device.

d. 12,000 pound tension; hold three minutes. Record initial and final readings from load indicating device.

e. Slowly release load.

After release of proof load, remove chain assembly, tensioning assembly, and disassemble test fixtures.

Inspect ring fitting and concrete in immediate area of fitting for signs of distress.

6-4 Proof Load Test on Lateral Tie-Down Proof Test Procedure

The following is a general test procedure for proof loading the tie-down ring.

6-4.1 Special Safety Precautions for Proof Test

6-4.1.1 Barricade or rope off test area around tie-down fittings. Secure test area size of 50 feet by 70 feet.

6-4.1.2 Provide secondary restraints to proof load system using a 1-inch (25-mm) diameter nylon rope secured to adjacent tie-downs. Nylon rope to be a minimum length of 25 feet and is to be secured to proof test load system in a slack condition; absorbing load only in the event of an unanticipated release of the primary tie-down fittings.

\4\

6-4.2 Connect a chain assembly and shackle to the hold down ring to be tested. A hydraulic pump, jack stand (similar to on in Figure 5-1) and measuring system could be set up by the test engineer that is suitable to apply the loads described. Apply load (T) at an angle of 70 degrees from the ground surface, shown in Figure 6-1. Use crane overload prevention equipment as shown in Figure 6-1.

/4/

**6-4.3 Lateral Tie-Down Proof Test Procedure.**

- a. Locate the centerpoint of the lateral pad eyes using a steel measuring tape to locate pick point for lifting device.
- b. Install dynamometer and associated rigging in accordance with Figure 6-3.
- c. Check and adjust chain assembly to ensure 70-degree angle is maintained. Use turnbuckle to adjust as necessary.
- d. Apply proof load as described in paragraph 6-4.4.
- e. Inspect assembly, engine restraint fittings, and surrounding concrete pavement for signs of distress.

6-4.4 Slowly induce tension in chain assembly. Increase load in increments as specified in a. through e. below:

- a. 2349 pound tension; hold one minute. Record initial and final readings from load indicating device.
- b. 7047 pound tension; hold one minute. Record initial and final readings from load indicating device.
- c. 9396 pound tension; hold one minute. Record initial and final readings from load indicating device.
- d. 11,276 pound tension; hold three minutes. Record initial and final readings from load indicating device.
- e. Slowly release load.

After release of proof load, remove chain assembly, tensioning assembly, and disassemble test fixtures.

Inspect ring fitting and concrete in immediate area of fitting for signs of distress.

Figure 6-1 Diagonal Embedment

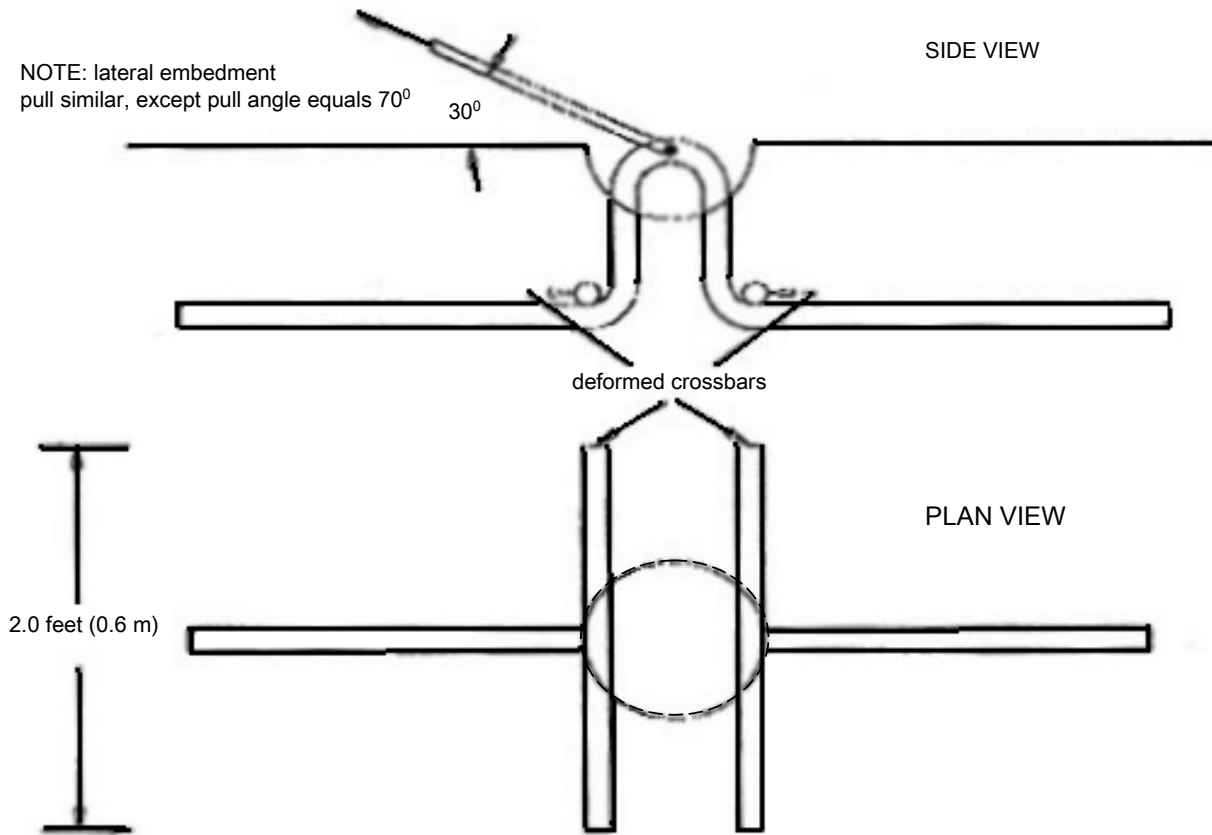



**Figure 6-2 Diagonal Embedment Pull**

2) Note: Turnbuckles are shown for the purpose of making incremental adjustments to maintain directional pull angles as shown in Fig 6-1. Substitution of exact length slings (cable) is an acceptable alternative.

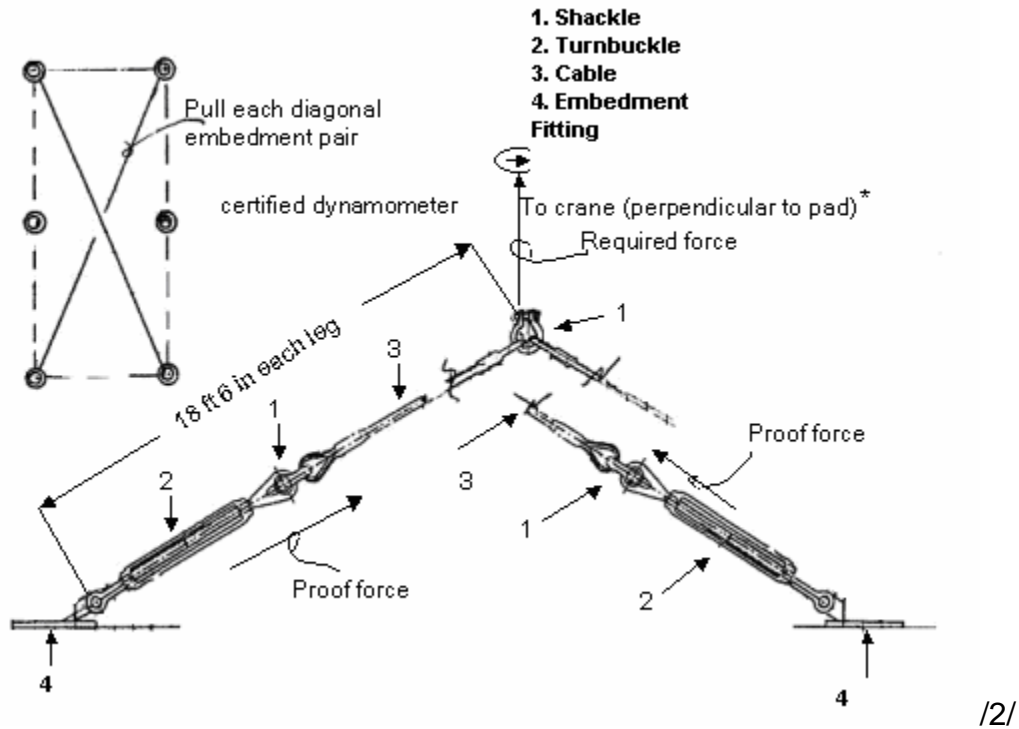

Diagonal Embedment Pull Pproofs (lbs-restraint chain)	Plift (lbs-crane or jack)
1250	1250
3750	3750
7500	7500
12000	12000

\* Use of a certified dynamometer is essential to prevent system overload. In lieu of a certified crane, a calibrated jack may be used

Use 7.5 ton capacity (minimum) chain fall between the crane hooks and the dynamometer to gradually apply the load. See figure A-6.

Figure 6-3 Lateral Embedment Pull

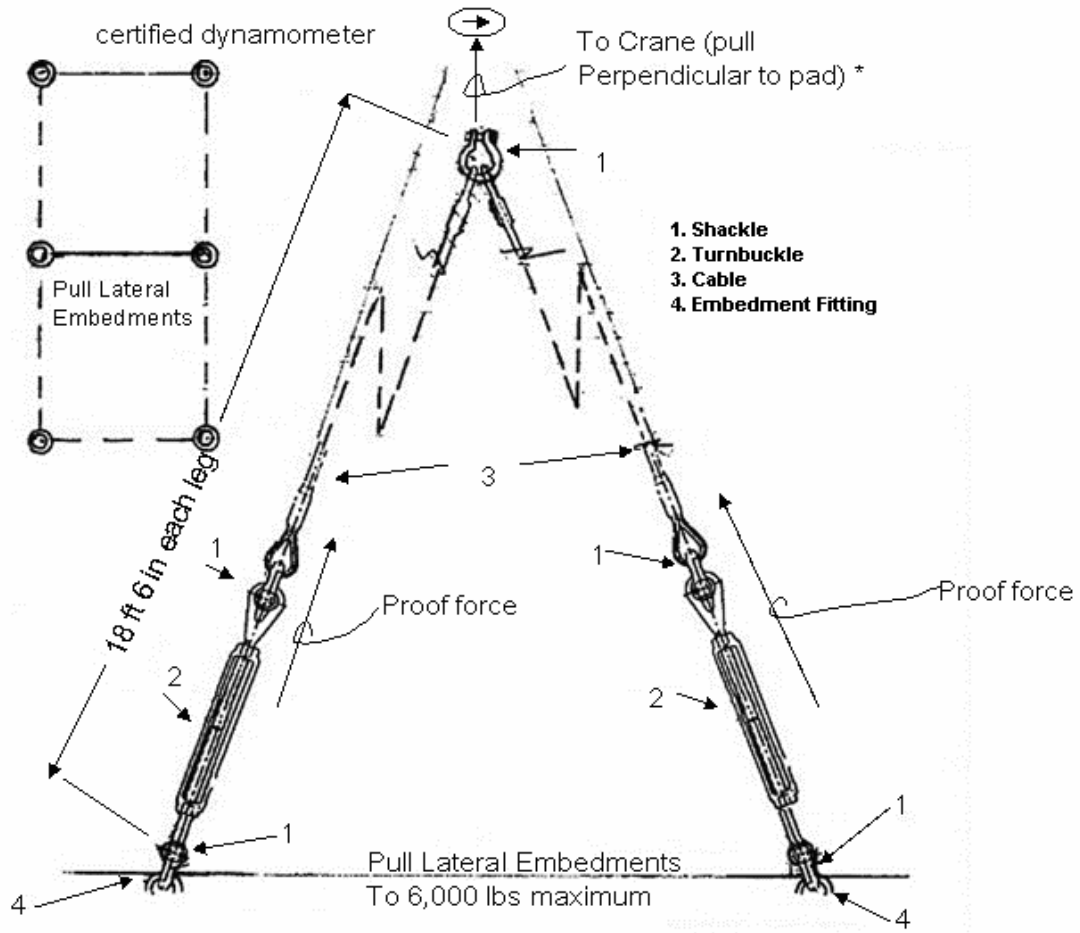

Diagonal Embedment Pull Pproofs (lbs-restraint chain)	Plift (lbs-crane or jack)	Prouded (lbs-crane or jack)
1250	2349	2300
3750	7047	7000
5000	9396	9300
6000	11276	11200

\* Use of a certified dynamometer is essential to prevent system overload. In lieu of a certified crane, a calibrated jack may be used

Also, recommend using a 7.5 ton capacity (minimum) chain fall between the crane hooks and the dynamometer to gradually apply the load. See figure A-6.

**6-5 INSPECTION PROCEDURES FOR T-56 TIE-DOWN FITTINGS (ONCE EVERY 5 YEARS).**

- a. Clean the mooring eyes with a wire brush.
- b. Visually inspect the fitting for cracks and damage.
- c. Measure the bar diameter for wear. If excessive wear is observed (bar diameter less than 95% of the original "as built" condition, replace mooring eye. NOTE: NAVFAC standard drawing 1404856 calls for 1-inch (25-mm) diameter steel mooring eye.
- d. Inspect the surrounding concrete surface for cracking or spalling. Spalls and voids deeper than 1 inch (25 mm) will be repaired within 1 foot (0.3m) of tie-down fitting. Other than hairline cracks, all cracks with 1 in (25 mm) of tie-down fitting will be repaired in accordance with UFC 3-270-03, *Operation and Maintenance: Concrete Crack and Partial Depth Spall Repair* or UFC 3-270-04, *Concrete Repair*.

\4\

- e. Inspect the tie-down every 5 years in accordance with the above noted procedure and visually inspect the fitting prior to every use.

/4/

- f. Inspect the concrete surrounding the tie downs. Use a 12oz ball peen hammer to tap and sound the concrete. See Figure A-2 and A-3.

**6-5 RECOMMENDED PROOF TEST ASSEMBLY (ONCE EVERY 5 YEARS).**

Proof test, ring embedments, T-56 standard power check pad using crane:

6-5.1 Fabricate one pair cable set (two 18'-6" legs) as shown in figure 6-2. This two-leg set can be used for pulling both diagonal ring embedment pairs at the correct angles. The same cable set can be used to pull the lateral ring embedment pair at the correct angles.

Note that the crane cable must be perpendicular to the power check pad plane. This can be accomplished by using a plumb bob as a sight to line up the crane cable.

6-5.2 Note that a pound force pulling table is given in both figures 6-2 and 6-3. The "required force" column provides the pull required by the crane to produce the equivalent "proof force" on the ring embedment. The maximum value in the "required force" column must not be exceeded for either pulling configurations defined in Figures 6-2 and 6-3, respectively.

6-5.3 The load cell may be placed in the common cable line to the crane, thus the "required force" column should be used to read the load cell measurements. For example, pulling with a force of 12,000 pounds by the crane for the configuration shown in Figure 6-2 is

equivalent to pulling both diagonal embedments to 12,000 pounds and, therefore both ring embedments are proved.

6-5.4 It remains only to follow the steps in NAVAIR Instruction 17-1-537 beginning with Para 1.3.2 and ending with 1.3.4. Note that the proof of the lateral ring embedments is taken to 6000 pounds, rather than 12,000 pounds used in the diagonal embedment.

6-5.5 Scheduling and Performance Responsibility.

Scheduling of inspections and tests is the responsibility of the AIMD Power Plants Officer (MALS, Marine Logistics Squadron) or his designated representative tasked with overseeing the daily operation of the test facility. Inspection and tests must be made by qualified personnel familiar with inspection and certification of load handling devices. Qualified personnel shall be regularly engaged with weight testing, heavy industrial rigging applications, \2\ have attended a nationally recognized crane, rigging and lifting certification school, /2/ or be approved by the NAVFAC Criteria Program.

6-5.6 Inspection and Test Results.

6-5.6.1 Promptly initiate necessary action to correct discrepancies found during inspections and tests.

6-5.6.2 Furnish a copy of the deficiencies found and the required corrective action to NAVAIR Lakehurst and the NAVFAC Atlantic, Special Assistant for Aviation Facilities.

6-5.7 \1\ Pulling System Requirements

6-5.7.1 The crane must satisfy working load capacity of 24,000 pounds minimum, and meet the requirements of P 307, *Management of Weight Handling Equipment*.

\4\

6-5.7.2 All other components of the pulling system must satisfy working load capability of at least 13,000 pounds and should be Non-Destructive Inspected (NDI) in accordance with NAVAIR 17-1-537 manual \2\ within the 30 days /2/ prior to use in pull testing engine restraints. /1/ If the original proof test certification for the test gear is available, the weight test director has the option to defer the NDI requirement for the test gear based on his visual inspection and review of the usage history of the test gear.

/4/

APPENDIX A ENGINE TEST CELLSUPPORTING PHOTOGRAPHS OF  
ENGINE RESTRAINT TEST FITTINGS

Figure A-1 T-56



Figure A-2Examples of Spalling

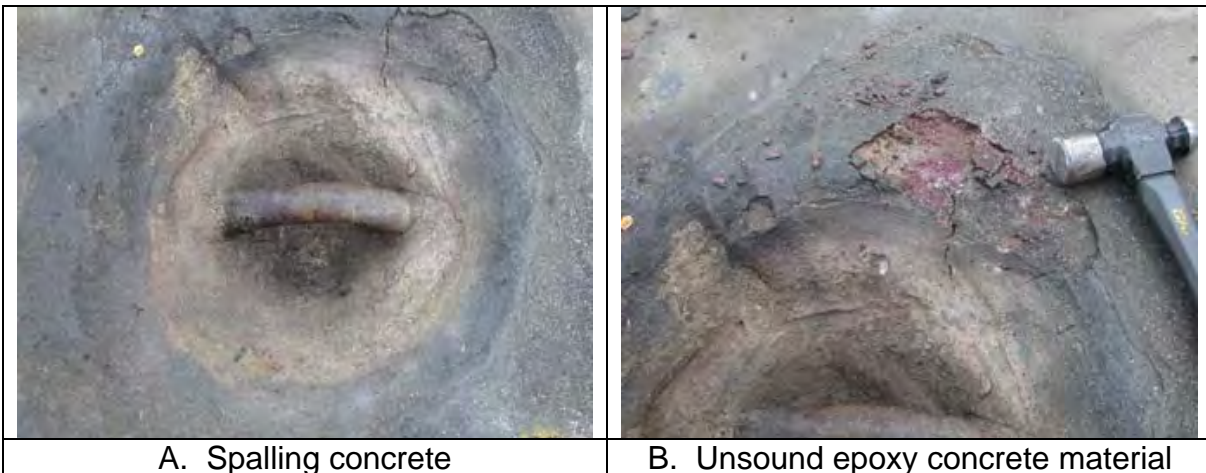

Figure A-3 Examples of Map Cracking

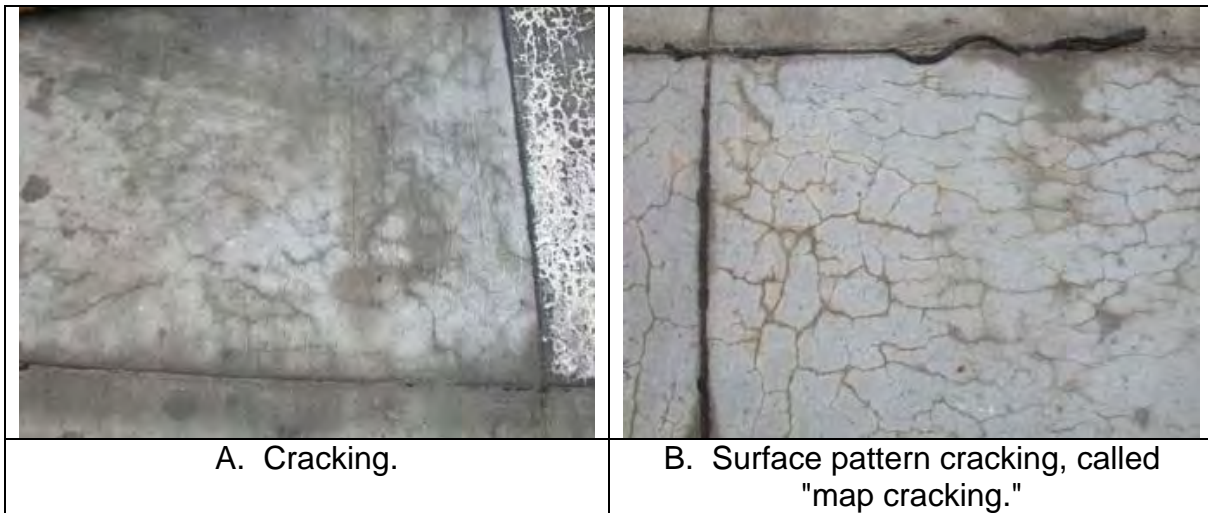

Figure A-4 T-56 Proof Test setup (without Chainfall)



**Note:** This photo shows the detailed preparation necessary for a successful proof test: PW crew, crane, rigging gears and tension gage. The safety barricades were not yet in place when this photo was taken. Caution must be exercised to ensure that personnel and equipment are not injured or damaged due to an unanticipated release of the fitting.



**Figure A-5 Example of Tie Down & NAVAIR ADAPTER RING**

**(DO NOT LOAD TEST WITH THIS ADAPTER RING!)**



**Figure A-6 T-56 Proof Test with Dynamometer, 7.5 ton Chain Fall and 40 Ton Hydraulic Mobile Crane**



**NOTE: Use of chain fall and dynamometer to increment the load applied to the restraint assembly allows for a very safe, controlled application of the proof load.**

## **APPENDIX B BASIS OF DESIGN (T-10 JET ENGINE TEST CELL)**

- Design entire building for expansion and contraction because of the temperature differential caused by engine testing. Building components should return to their original position once heat has dissipated
- The buildings are extensions of the aircraft. Building instrumentation and controls must run the engine the same way the aircraft does.
- The building utility systems must be pure so as not to contaminate the engine.
- The fuel system is calibrated so as to provide the exact flow rate the operator calls for.
- The fire detection/suppression system is critical to the safety of personnel and equipment. There will be small engine fires that are extinguished by the spurt system. All logic within the controls must be field verified by the commissioning process.
- The Test Cell Enclosure is designed for 4" of water cell depression; inlet velocity should be less than 50 feet per second, velocity distortion ratio should be less than 1.
- The Test Cell has a standard airflow configuration enabling the engine to be tested within 3% of gold plate data for a standard day and standard temperature.
- Noise Criteria: not to exceed 85 decibels at 250 feet
- Acoustical loading from Getter calculations: 30 pounds square foot in the augments & the exhaust stack`
- Design augments for 500 degree Fahrenheit temperature change.
- It is essential for Augments centerline & the engine restraint system centerline to coincide to prevent uneven heat distribution of the augments.
- Building temperatures in the Run Room can reach temperatures up to 200 degrees Fahrenheit.
- All fasteners are captivated to prevent accidental loss and F.O.D. (foreign object damage) potential.
- The doors are interlocked to prevent someone from coming into run room during engine testing.



- The fire suppression system is interlocked with fuel system to provide for a controlled shut down of engine.
- The fire suppression spurt system is intended to extinguish small engine fires. Water deluge is activated in the event the spurt fails to extinguish the fire.

The Run Room wall panels are protected additionally by amour plate that protects personnel and equipment against engine rupture failure and engine disintegration during blade out from a catastrophic engine failure.

\4\

#### **Turboshaft Design Criteria**

- Cell Depression - 2" of water or less.
- Cell room velocity around engine - 50 FPS or less (in turboshaft cells the velocity is well below 50 FPS).
- Maximum velocity at exhaust stack exit - 400 FPS - This is to limit regenerated noise.
- There should be no exhaust gas (engine or dyno) recirculation in the cell.
- Maximum noise level at 250 foot radius (centered at engine tailpipe exit) 85 dB.

/4/

APPENDIX C SAMPLE SUPPORTING STATEMENT TO WAIVER REQUEST



DEPARTMENT OF THE NAVY  
U.S. NAVAL STATION  
PSC 1005, BOX 25  
FPO AE 09593-1000

11010  
Ser 20/0077  
15 FEB 2001

From: Commanding Officer, U.S. Naval Station, Guantanamo Bay  
To: Commander, Atlantic Division, Naval Facilities  
Engineering Command

Subj: FY01 RO23 REPAIR BEQ BUILDING 1670, GUANTANAMO BAY, CUBA

Ref: (a) Naval Facilities Engineering Command, Planning and  
Design Policy Statement - 94-01, Barrier Free Design  
Accessibility Requirements, 26 May 94 (Revised 01 Jun  
97)

1. Per reference (a), the use of BEQ Building 1670, Naval  
Station, Guantanamo Bay, Cuba, is specifically restricted to  
able-bodied military personnel.

2. Point of Contact is Mr. Craig Sherman at COMM: 011-53-99-  
4162 ext 205 or DSN: 723-3960 ext 205, or e-mail  
[n204@usnbgtdc.navy.mil](mailto:n204@usnbgtdc.navy.mil).

  
P. A. SOARES  
By direction

**APPENDIX D PROOFLOAD STATEMENT OF CONFORMANCE**

**Proofload Statement of Conformance**

**[Location]**

**[Date]**

**This statement attests to the satisfactory performance of the subject testing of tie-down fittings.**

**[Type of test fitting] was tested with a load of [proofload test weight] in accordance with UFC 4-212-01 with a satisfactory test result.**

**The [Name of organization supplying test equipment] attests that the gauges used during testing were calibrated within the past year in accordance with standard Navy calibration practices.**

**[SIGNATURE OF INSPECTOR]**

**[Name of Inspector]**

**[Title]**

**[Code \_\_\_\_\_]**

**[Name of Command]**

**[Contact Information]**

**NOTE: A copy of this statement must be maintained by the AIMD Officer.**

**APPENDIX E AVIATION TEST FACILITIES, AIRCRAFT AND ENGINE DATA**

**Table E-1 Aircraft Engine Thrust Data**

Engine	Aircraft	Thrust (Mil) - Lbs	Thrust (A/B) - Lbs
TF30-P-414A	F-14A/B	12,350	20,900
TF34-GE-400B	S-3A	9,275	
F110-GE-400	F-14D	16,333	26,950
F402-RR-408A	AV-8B	23,390	
F404-GE-400	F/A-18	10,606	16,002
F404-GE-402	F/A-18C/D	11,875	17,775
F405-RR-401	T-45A	5,775	
F414-GE-400	F/A-18E/F	Contact NAVAIR NAWC Lakehurst	22,000
J52-P-408A	EA-6B	11,200	
J85-GE-4B	T-2C	2,950	
J85-GE-21	F05F	3,500	
T56-A-427	E-2C	Approx 9,940	
T56-A-425	E-2C/C-2A	Approx 9,500	
T56-A-14	P-3	Approx 8,000	
T56-A-16	C-130	Approx 8,500	

## APPENDIX F REFERENCES

AIRCRAFT CHARACTERISTICS DATABASE (<http://www.uscost.net/aircraftcharacteristics/>)

NAVFAC P-307, *Management of Weight Handling Equipment*, [www.navfac.navy.mil](http://www.navfac.navy.mil).

NAVFAC P-80.3, *Facility Planning Factor Criteria for Navy/Marine Corps Shore Installations Safety Clearance*, [www.navfac.navy.mil](http://www.navfac.navy.mil)

NAVAIR 17-1-537, *Depot Maintenance Proof Load Diagrams, Restraint Fittings and Aircraft Restraining Devices and Related Components*, <http://www.natec.navy.mil>

NAVAIR 4790

OPNAVINST 4790.2, *Naval Aviation Maintenance Program*

UFC 1-200-01, *General Building Requirements*, <http://dod.wbdg.org>

UFC 3-260-01, *Airfield and Heliport Planning and Design*, <http://dod.wbdg.org>

UFC 3-580-10, *Design: Navy and Marine Corps Intranet Construction Standards*,  
<http://dod.wbdg.org>

UFC 4-010-01, *Design: DOD Minimum Antiterrorism Standards for Buildings*,  
<http://dod.wbdg.org>