

TLTS1 - INTERIOR DESIGN

Floor Finish		Wall Finish		Ceiling Finish		Room Height	Room Noise		
Preferred	Alternate	Preferred	Alternate	Preferred	Alternate	ft - in	Min NC	Max NC	SC
CT	SSP	CT	-	GPT	SSP	8' - 0"	35	40	40

TLTS1 - DOOR SCHEDULE

Mark	Type	Count	Height	Width	Notes
			ft - in	ft - in	
A	Single-Flush	1	7' - 0"	3' - 0"	

Room Description: Toilet, Shower, Single

NSF: 60

TLTS1

Plate Description: Room/Equipment Isometric

Scale:

Sheet
1

of
5

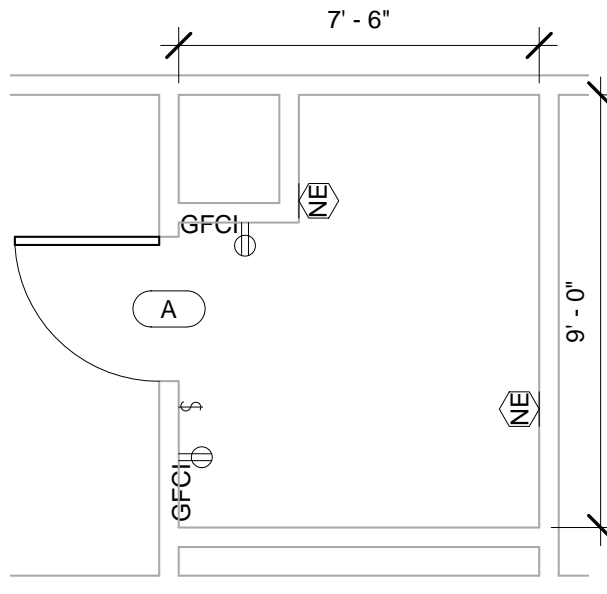

TLTS1 - FLOOR PLAN

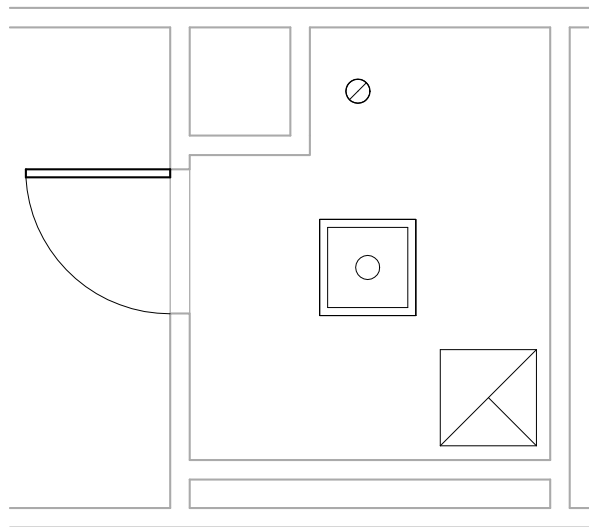

TLTS1 - CEILING PLAN

Room Description: Toilet, Shower, Single	NSF: 60	TLTS1	
Plate Description: Floor & Ceiling Plans	Scale: 1/4" = 1'-0"	Sheet 2	of 5

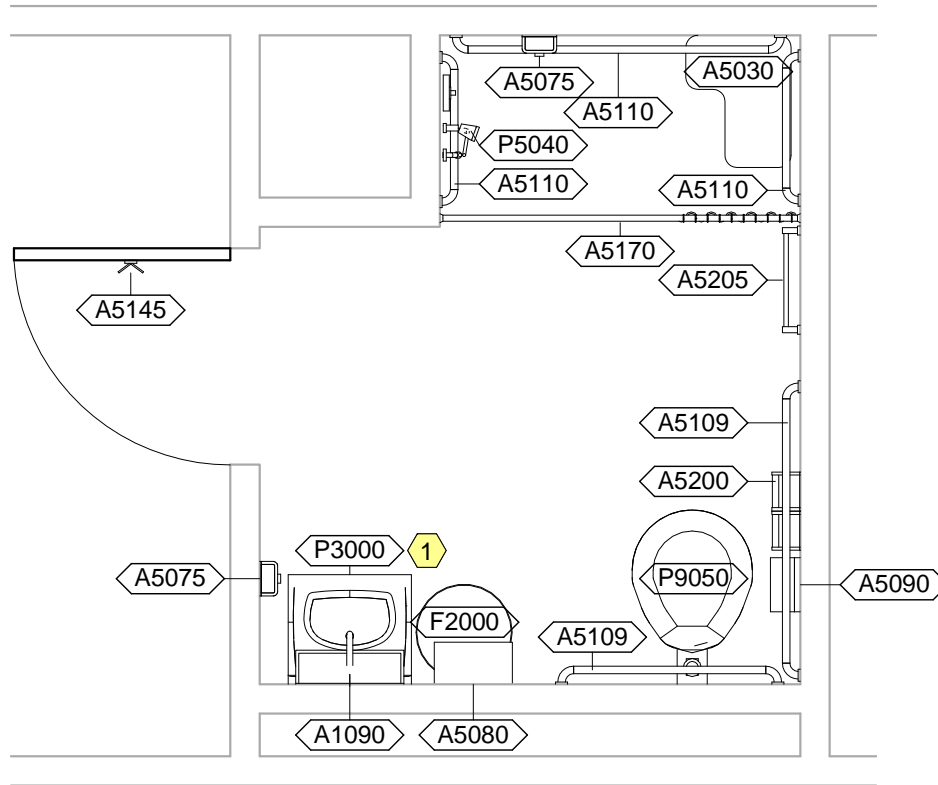

TLTS1 - NOTES

- 1 JSN P8710, Utility Center, shall be included in Navy projects only.

Room Description: Toilet, Shower, Single	NSF: 60	TLTS1	
Plate Description: Equipment Plan	Scale: 3/8" = 1'-0"	Sheet 3	of 5

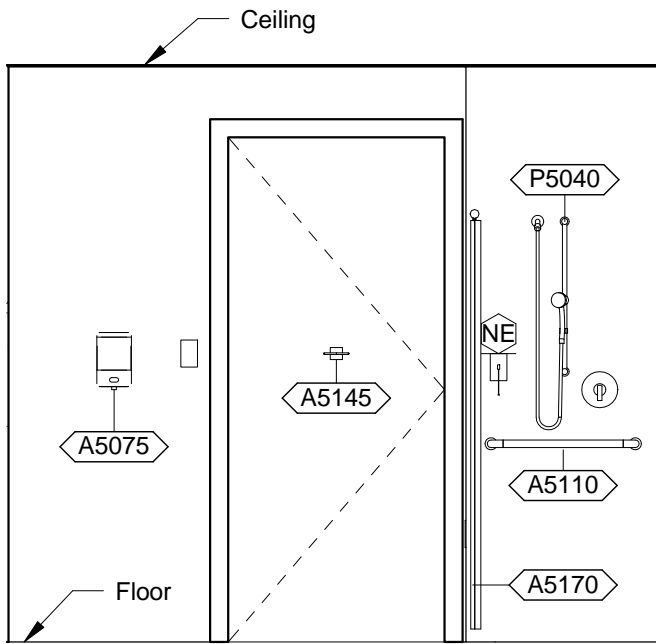

TLTS1 - PLAN WEST

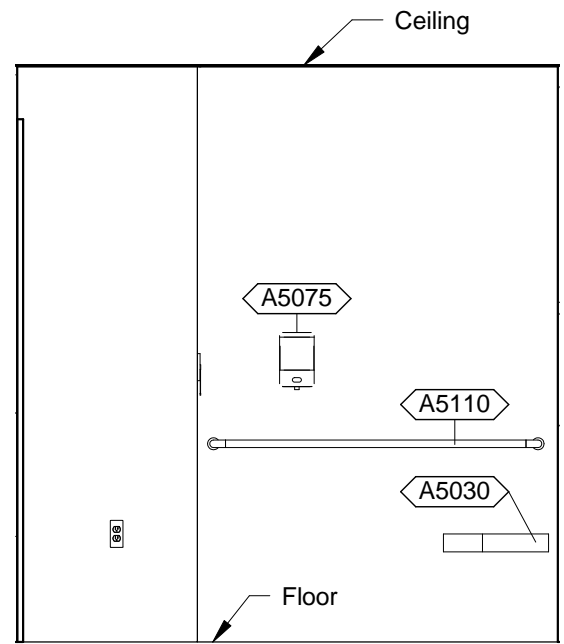

TLTS1 - PLAN NORTH

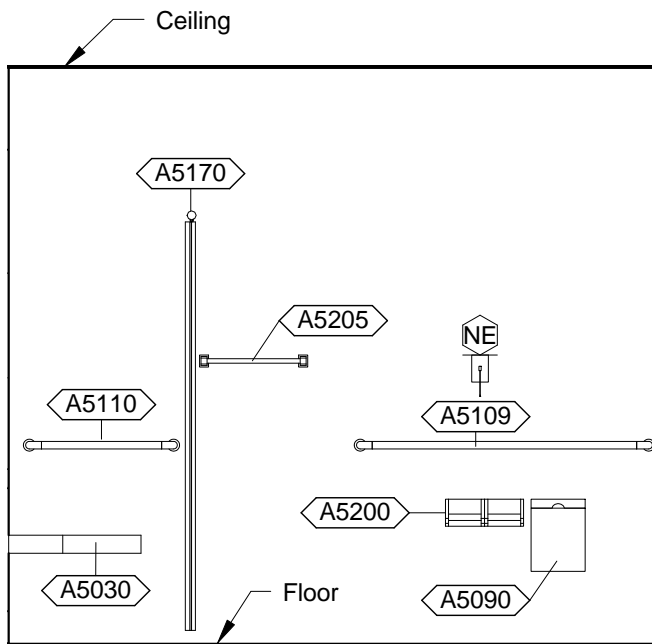

TLTS1 - PLAN EAST

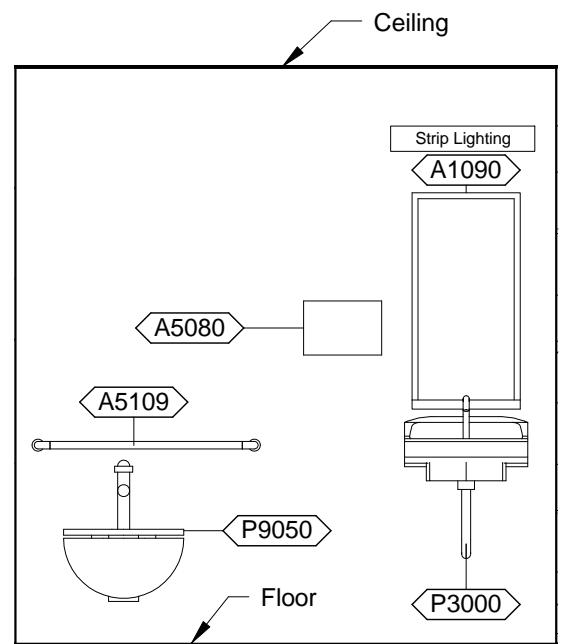

TLTS1 - PLAN SOUTH

Room Description: Toilet, Shower, Single	NSF: 60	TLTS1	
Plate Description: Interior Room Elevations	Scale: 3/8" = 1'-0"	Sheet 4	of 5

TLTS1 - EQUIPMENT SCHEDULE

JSN	Nomenclature	Qty	Logistics				Utilities					
			AR	NA	AF	VA	1	2	3	4	5	6
A1090	Mirror, Float Glass, With SS Frame & Shelf	1	A	A	A	A	-	-	-	-	-	-
A5030	Bench, Stall, Shower, Built In	1	A	A	A	A	-	-	-	-	-	-
A5075	Dispenser, Soap, Disposable	2	C	C	C	C	-	-	-	-	-	-
A5080	Dispenser, Paper Towel, SS, Surface Mounted	1	A	A	A	A	-	-	-	-	-	-
A5090	Disposal, Sanitary Napkin, SS, Surface Mounted	1	A	A	A	A	-	-	-	-	-	-
A5109	Grab Bar, 1-1/4" Dia., SS, 2 Wall, W/C Accessible	2	A	A	A	A	-	-	-	-	-	-
A5110	Grab Bar, 1-1/4" Dia., SS, 2 Wall, Shower Use	3	A	A	A	A	-	-	-	-	-	-
A5145	Hook, Garment, Double, SS, Surface Mounted	1	A	A	A	A	-	-	-	-	-	-
A5170	Rod, Shower Curtain, 1"Diameter, W/Curtain & Hooks	1	A	A	A	A	-	-	-	-	-	-
A5200	Dispenser, Toilet Tissue, SS, 2-Roll, Surface Mntd	1	A	A	A	A	-	-	-	-	-	-
A5205	Bar, Towel, 1" Diameter, SS, Surface Mounted	1	A	A	A	A	-	-	-	-	-	-
F2000	Basket, Wastepaper, Round, Metal	1	C	C	C	C	-	-	-	-	-	-
P3000	Lavatory, Vitreous China, Straight Back	1	A	A	A	A	D	-	-	-	-	-
P5040	Shower, Single, Hand-Held	1	A	A	A	A	D	-	-	-	-	-
P9050	Toilet, Wall Hung, Siphon Jet	1	A	A	A	A	B	-	-	-	-	-

Room Description: Toilet, Shower, Single	NSF: 60	TLTS1	
Plate Description: Equipment Schedule	Scale:	Sheet 5	of 5