

Room Description: Eye, Vision Screening (EYVS1)	NSF: 120	EYVS1	
Sheet Description: Room/Equipment Isometric	Scale:	Sheet 1	of 5

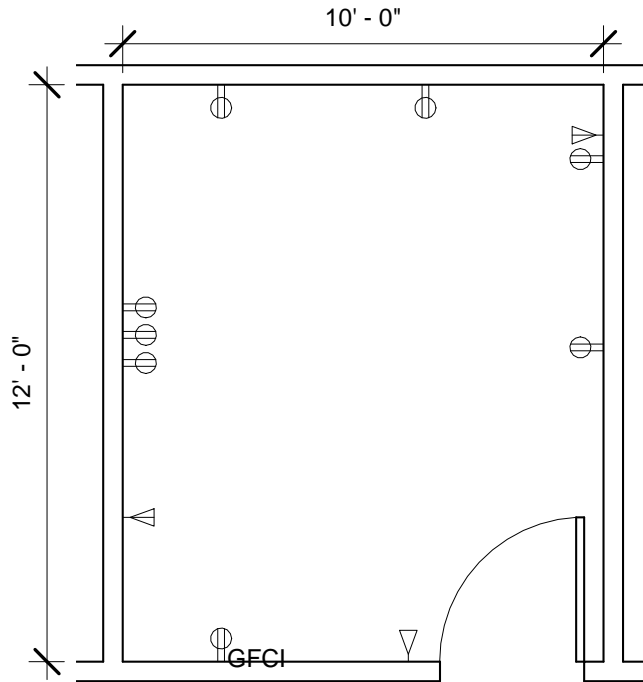

EYVS1 - FLOOR PLAN

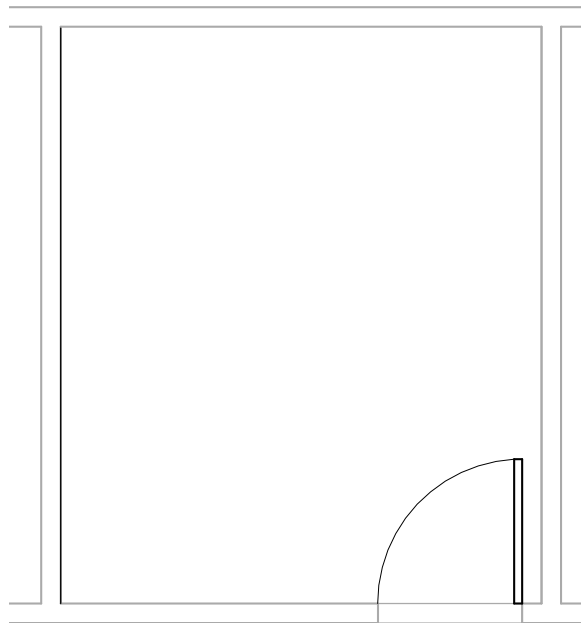

EYVS1 - CEILING MOUNTED EQUIPMENT PLAN

Room Description: Eye, Visual Screening (EYVS1)	NSF: 120	EYVS1	
Sheet Description: Floor & Ceiling Mounted Equipment Plans	Scale: 1/4" = 1'-0"	Sheet 2	of 5

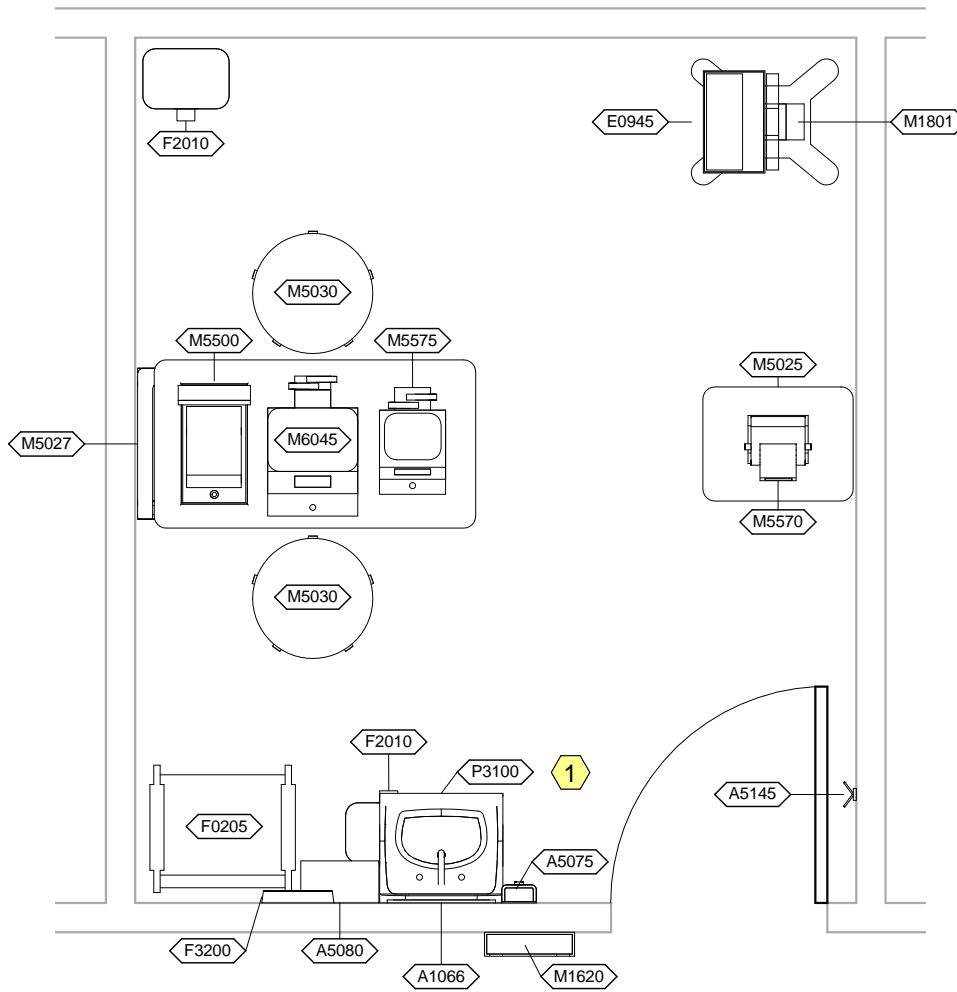

EYVS1 - NOTES

- 1 JSN P8710, Utility Center, shall be included in Navy projects only.

Room Description: Eye, Visual Screening (EYVS1)	NSF: 120	<h1>EYVS1</h1>	
Sheet Description: Equipment Plan	Scale: 3/8" = 1'-0"	Sheet <h2>3</h2>	of <h2>5</h2>

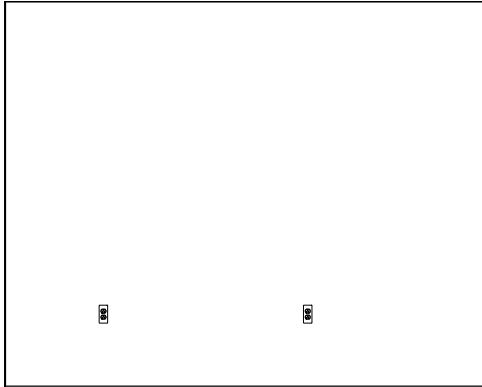

EYVS1 - NORTH ELEVATION

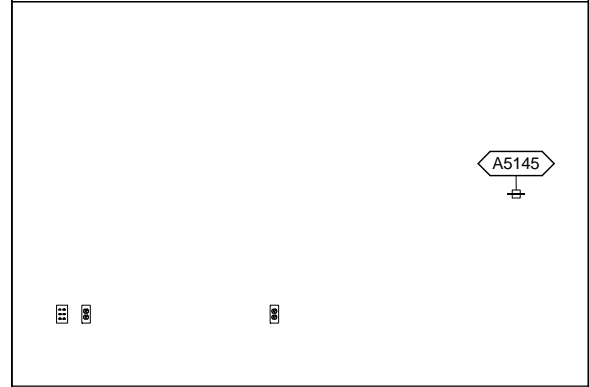

EYVS1 - EAST ELEVATION

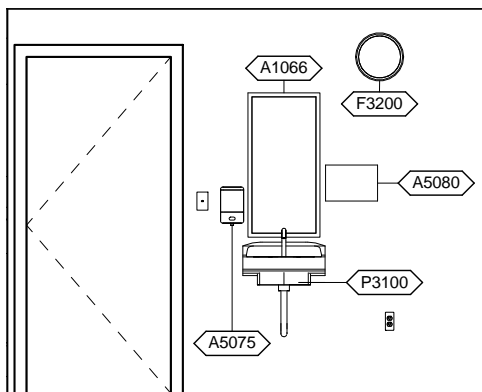

EYVS1 - SOUTH ELEVATION

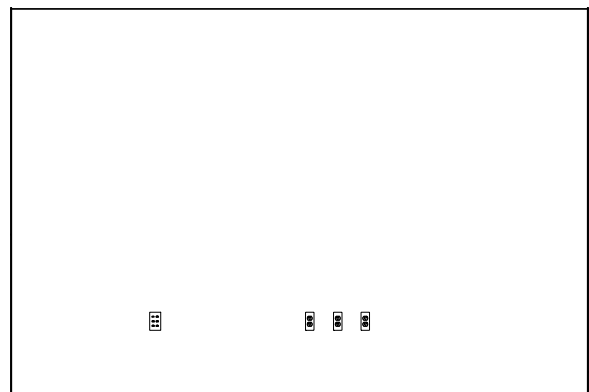

EYVS1 - WEST ELEVATION

Room Description: Eye, Visual Screening (EYVS1)	NSF: 120	<h1>EYVS1</h1>	
Sheet Description: Interior Room Elevations	Scale: 1/4" = 1'-0"	Sheet <h2>4</h2>	of <h2>5</h2>

EYVS1 - EQUIPMENT SCHEDULE

JSN	Nomenclature	Qty	LF	AR	Logistics			Utilities					
					NA	AF	VA	1	2	3	4	5	6
A1066	Mirror, Float Glass, With SS Frame	1		A	A	A	A	-	-	-	-	-	-
A5075	Dispenser, Soap, Disposable	1		C	C	C	C	-	-	-	-	-	-
A5080	Dispenser, Paper Towel, SS, Surface Mounted	1		A	A	A	A	-	-	-	-	-	-
A5145	Hook, Garment, Double, SS, Surface Mounted	1		A	A	A	A	-	-	-	-	-	-
E0945	Mobile, Workstation	1		-	-	-	-	-	-	-	-	-	-
F0205	Chair, Side With Arms	1		C	C	C	C	-	-	-	-	-	-
F2010	Basket, Wastepaper, Step-On	2		C	C	C	C	-	-	-	-	-	-
F3200	Clock, Battery, 12" Diameter	1		C	C	C	C	-	-	-	-	-	-
M1620	Holder, Chart, Patient, Wall or Door Mounted	1		A	A	A	A	-	-	-	-	-	-
M1801	Computer, Microprocessing, w/Flat Panel Monitor	1		C	C	C	C	-	A	-	-	-	-
M5025	Table, Instrument, Ophthalmic, Adjustable	1		C	C	C	C	-	A	-	-	-	-
M5027	Table, Multiple Instrument, Ophthalmic	1		C	C	C	C	-	A	-	-	-	-
M5030	Stool, Surgeon, Revolving	2		C	C	C	C	-	-	-	-	-	-
M5500	Autorefractor, Ophthalmic	1		C	C	C	C	-	A	-	-	-	-
M5570	Armed Forces Vision Tester	1		C	C	C	C	-	A	-	-	-	-
M5575	Tonometer, Noncontact	1		C	C	C	C	-	A	-	-	-	-
M6045	Corneal Topography Unit	1		C	C	C	C	-	A	-	-	-	-
P3100	Lavatory, Vitreous China, Slab Type	1		A	A	A	A	D	-	-	-	-	-

EYVS1 - DATA/TELEPHONE EQUIPMENT

JSN	Nomenclature	Qty	AR	Logistics		
				NA	AF	VA
A1010	Telecommunication Outlet	2	A	A	A	A
A1014	Telephone, Wall Mounted, 1 Line, with Speaker	1	A	A	A	A

Room Description: Eye, Visual Screening (EYVS1)	NSF: 120	EYVS1	
Sheet Description: Equipment Schedule	Scale:	Sheet 5	of 5