

DNXC1 - INTERIOR DESIGN

Floor Finish		Wall Finish		Ceiling Finish		Room Height	Room Noise		
Alt #1	Alt #2	Alt #1	Alt #2	Alt #1	Alt #2	ft - in	Min NC	Max NC	SC
VT	SV	GLG	GPT	AT1	-	8' - 6"	30	35	40

Room Description: Dental X-Ray, Cone Beam

NSF: 120

DNXC1

Plate Description: Room/Equipment Isometric

Scale:

Sheet
1

of
5

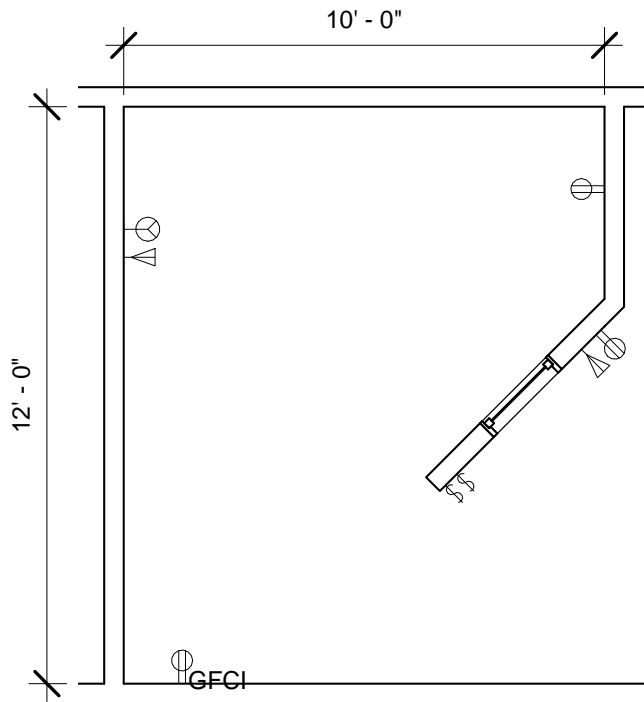

DNXC1 - FLOOR PLAN

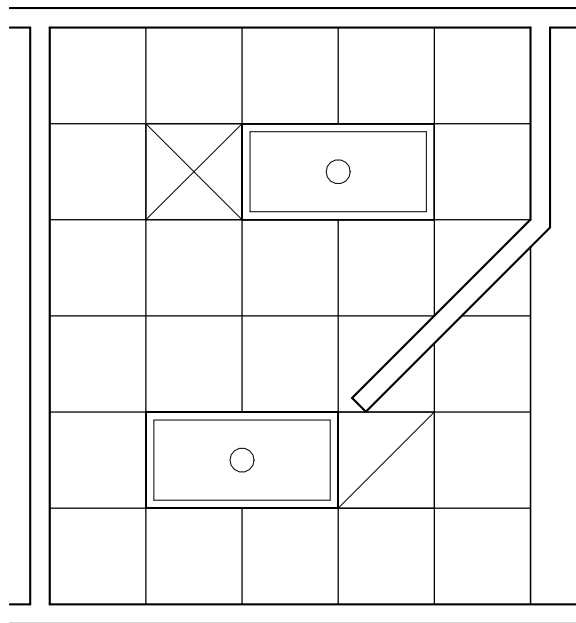

DNXC1 - CEILING PLAN

Room Description: Dental XRay, Intraoral/Panograph/Cephalometric	NSF: 120	DNXD1	
Plate Description: Floor & Ceiling Plans	Scale: 1/4" = 1'-0"	Sheet 2	of 5

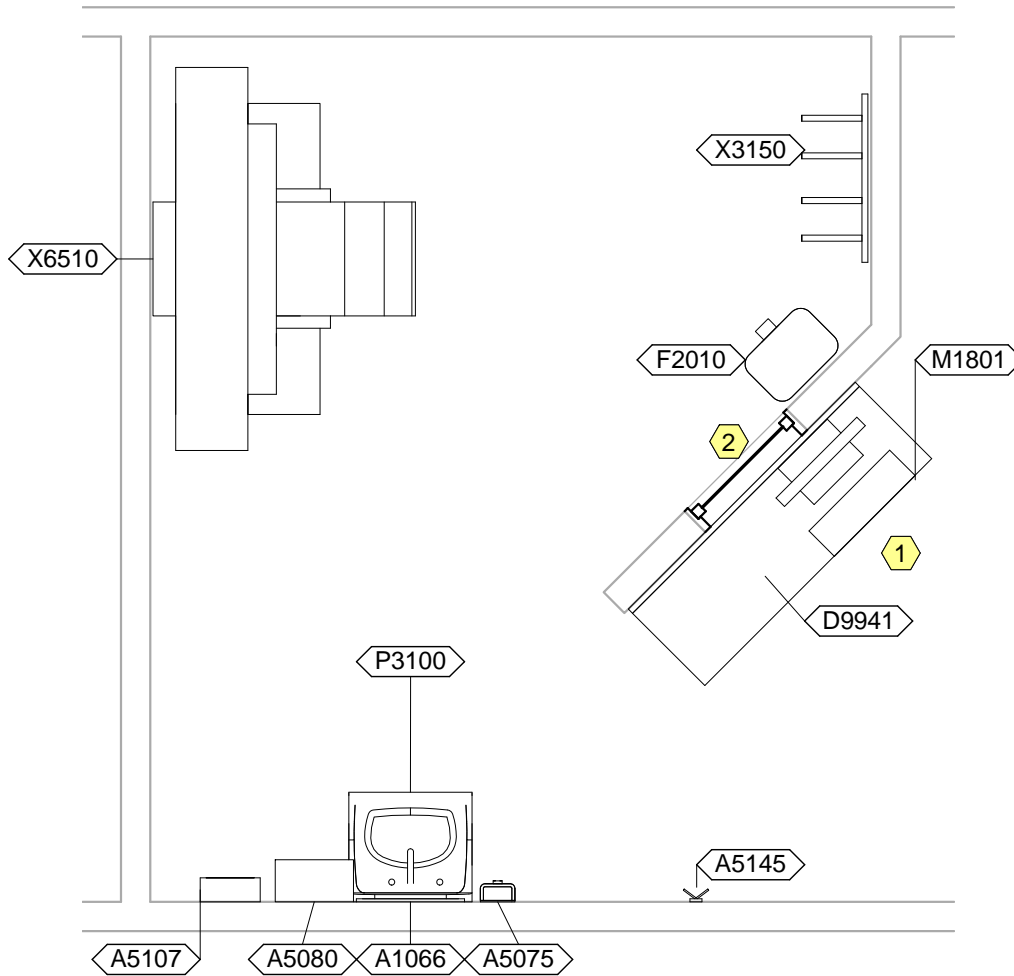

DNXC1 - NOTES

- 1 X-Ray Remote Control Unit.
- 2 Lead Glass View Window.

Room Description: Dental XRay, Intraoral/Panograph/Cephalometric	NSF: 120	DNXD1	
Plate Description: Equipment Plan	Scale: 3/8" = 1'-0"	Sheet 3	of 5

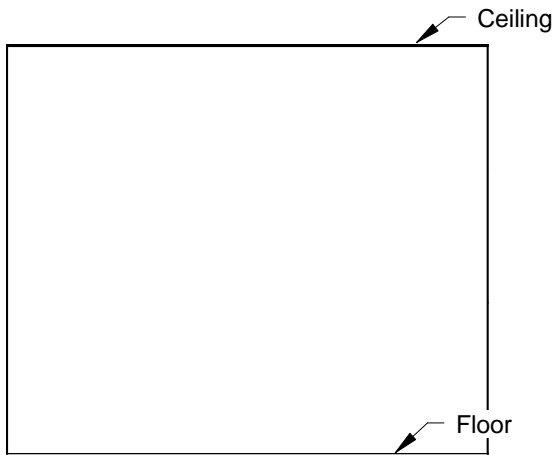

DNXC1 - PLAN NORTH

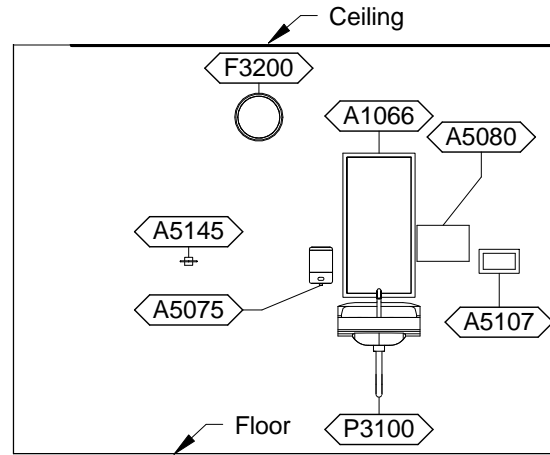

DNXC1 - PLAN SOUTH

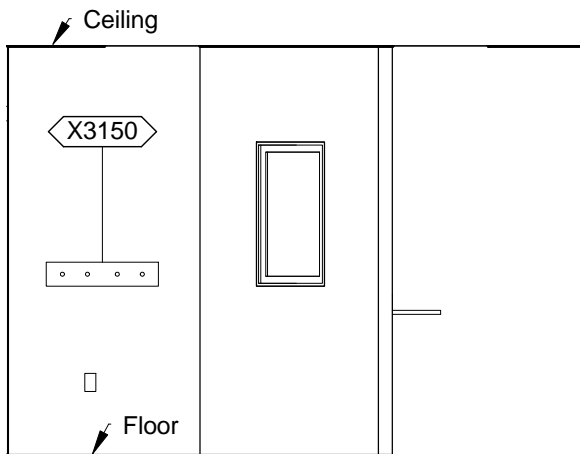

DNXC1 - PLAN EAST

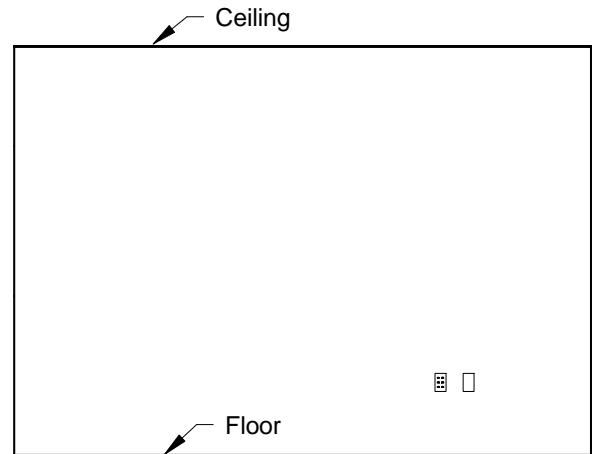

DNXC1 - PLAN WEST

<p>Room Description: Dental XRay, Intraoral/Panograph/Cephalometric</p>	<p>NSF: 120</p>	<p>DNXD1</p>	
<p>Plate Description: Interior Room Elevations</p>	<p>Scale: 1/4" = 1'-0"</p>	<p>Sheet 4</p>	<p>of 5</p>

DNXC1 - EQUIPMENT SCHEDULE

JSN	Nomenclature	Qty	Logistics				Utilities					
			AR	NA	AF	VA	1	2	3	4	5	6
A1066	Mirror, Float Glass, With SS Frame	1	A	A	A	A	-	-	-	-	-	-
A5075	Dispenser, Soap, Disposable	1	C	C	C	C	-	-	-	-	-	-
A5080	Dispenser, Paper Towel, SS, Surface Mounted	1	A	A	A	A	-	-	-	-	-	-
A5107	Dispenser, Glove, Surgical/Examination, Wall Mntd	1	C	C	C	C	-	-	-	-	-	-
A5145	Hook, Garment, Double, SS, Surface Mounted	1	A	A	A	A	-	-	-	-	-	-
D9941	Countertop, Laminated, 3/4" Thick	1	A	A	A	A	-	-	-	-	-	-
F2010	Basket, Wastepaper, Step-On	1	C	C	C	C	-	-	-	-	-	-
F3200	Clock, Battery, 12" Diameter	1	C	C	C	C	-	-	-	-	-	-
M1801	Computer, Microprocessing, w/Flat Panel Monitor	1	C	C	C	C	-	A	-	-	-	-
P3100	Lavatory, Vitreous China, Slab Type	1	A	A	A	A	D	-	-	-	-	-
X3150	Rack, Apron/Gloves, Wall Mounted	1	A	A	A	A	-	-	-	-	-	-
X6510	Radiographic Unit, Dental, Cone Beam, 3-D Imaging	1	F	F	F	F	-	F	-	-	-	-

DNXC1 - DATA/TELEPHONE EQUIPMENT

JSN	Nomenclature	Qty	Logistics			
			AR	NA	AF	VA
A1010	Telecommunication Outlet	2	A	A	A	A

Room Description: Dental XRay, Intraoral/Panograph/Cephalometric	NSF: 120	DNXD1	
Plate Description: Equipment Schedule	Scale:	Sheet 5	of 5