

DNSC6 - INTERIOR DESIGN

Floor Finish		Wall Finish		Ceiling Finish		Room Height	Room Noise		
Preferred	Alternate	Preferred	Alternate	Preferred	Alternate	ft - in	Min NC	Max NC	SC
SV	ET	GLG	-	AT2	-	8' - 6"	30	35	40

DNSC6 - DOOR SCHEDULE

Mark	Type	Count	Height	Width	Notes
			ft - in	ft - in	
A	Single-Flush	1	7' - 0"	3' - 0"	

Room Description: Dental Instrument Storage, Sterile, Medium

NSF: 120

DNSC6

Plate Description: Room/Equipment Isometric

Scale:

Sheet

1

of

6

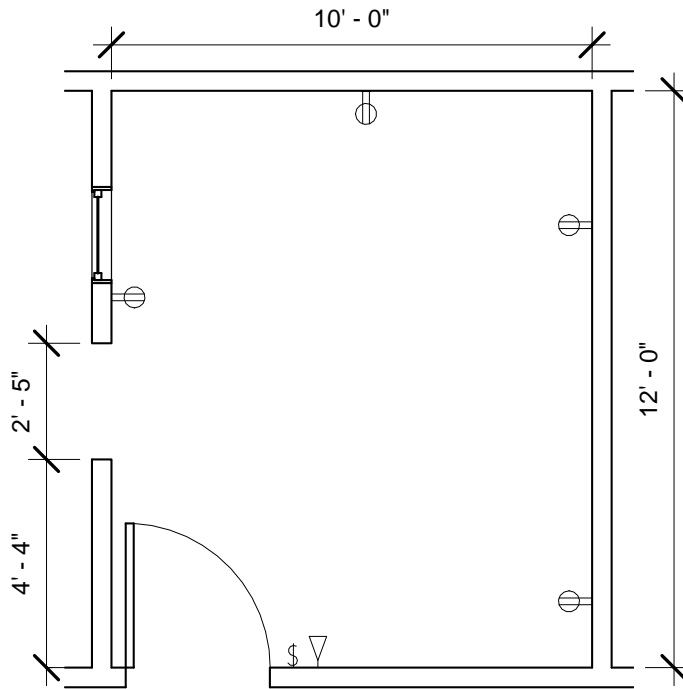

DNSC6 - FLOOR PLAN

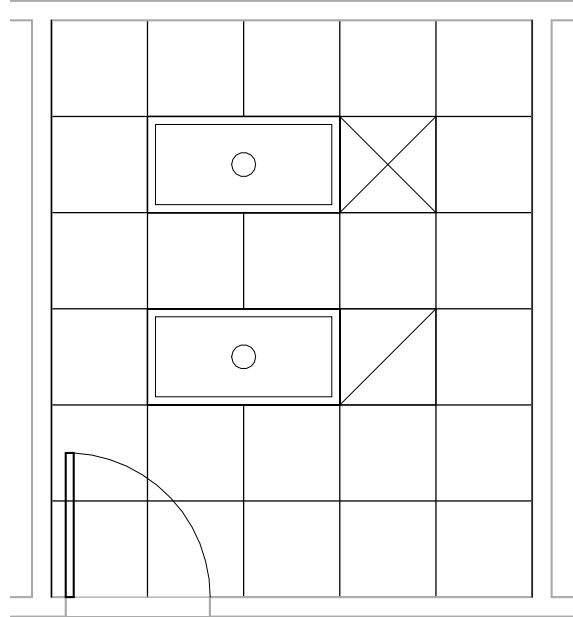

DNSC6 - CEILING PLAN

Room Description: Dental, Instrument Sterile Storage, Medium	NSF: 120	DNSC6	
Plate Description: Floor & Ceiling Plans	Scale: 1/4" = 1'-0"	Sheet 2	of 6

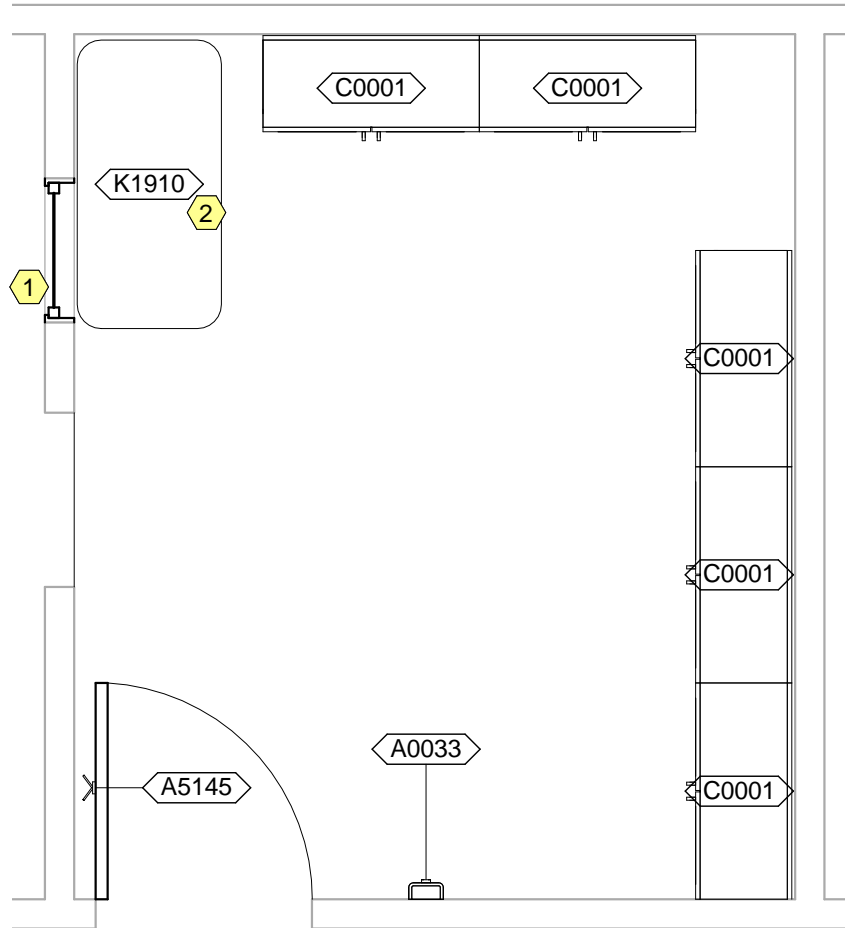

DNSC6 - NOTES

- 1 Pass Window, 24"W x 36"H.
- 2 JSN K1910, Table, Work, Stainless Steel, shown as 48"W x 24"D, shall have casters.

Room Description: Dental, Instrument Sterile Storage, Medium	NSF: 120	DNSC6	
Plate Description: Equipment Plan	Scale: 3/8" = 1'-0"	Sheet 3	of 6

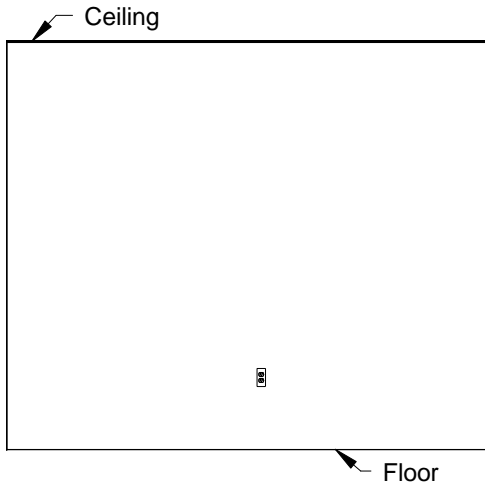

DNSC6 - PLAN NORTH

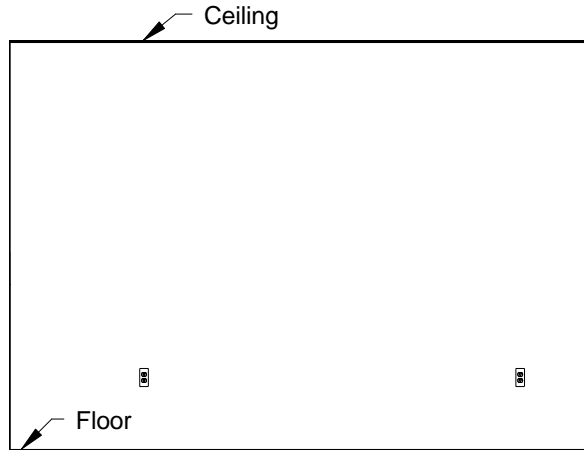

DNSC6 - PLAN EAST

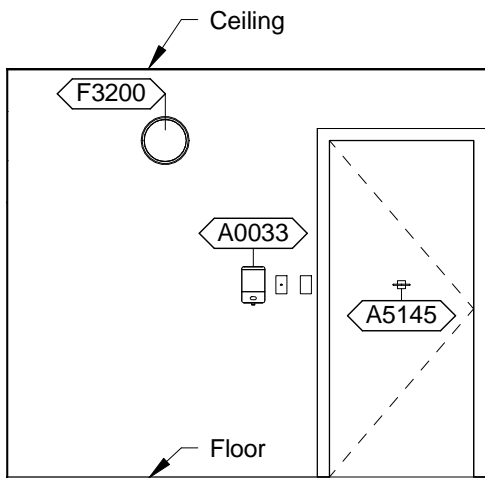

DNSC6 - PLAN SOUTH

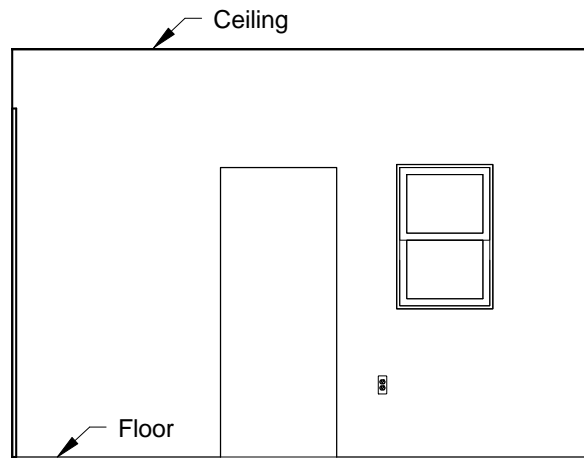

DNSC6 - PLAN WEST

Room Description: Dental, Instrument Sterile Storage, Medium	NSF: 120	DNSC6	
Plate Description: Interior Room Elevations	Scale: 1/4" = 1'-0"	Sheet 4	of 6

DNSC6 - EQUIPMENT SCHEDULE

JSN	Nomenclature	Qty	Logistics				Utilities						
			AR	NA	AF	VA	1	2	3	4	5	6	
A0033	Hand Sanitizer, Wall Mounted	1	-	-	-	-	-	-	-	-	-	-	-
A5145	Hook, Garment, Double, SS, Surface Mounted	1	A	A	A	A	-	-	-	-	-	-	-
C0001	Cabinet, Floor Standing, 2 GDO, ST, 60x36x16	5	A	A	A	A	-	-	-	-	-	-	-
K1910	Table, Work, Stainless Steel	1	A	A	A	A	-	-	-	-	-	-	-

DNSC6 - DATA/TELEPHONE EQUIPMENT

JSN	Nomenclature	Qty	Logistics			
			AR	NA	AF	VA
A1014	Telephone, Wall Mounted, 1 Line, with Speaker	1	A	A	A	A

Room Description: Dental, Instrument Sterile Storage, Medium	NSF: 120	DNSC6	
Plate Description: Equipment & Data Schedules	Scale:	Sheet 5	of 6

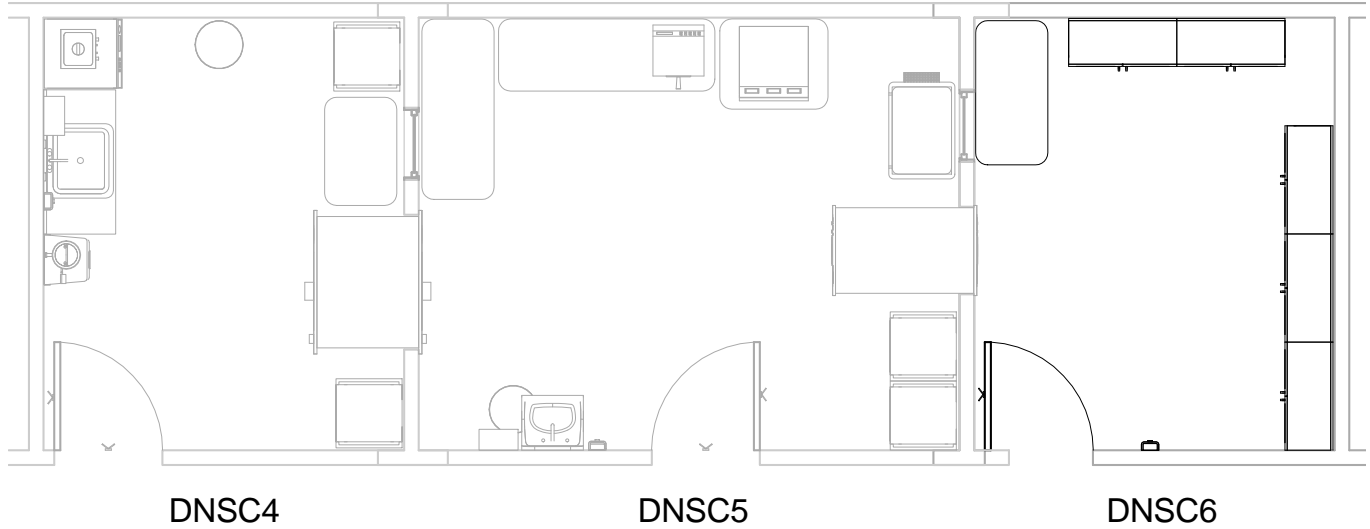

Room Description: Dental, Instrument Sterile Storage, Medium	NSF: 120	DNSC6	
Plate Description: Flow Diagram	Scale: 3/16" = 1'-0"	Sheet 6	of 6