

PORCELAIN ROOM, DENTAL PROSTHODONTIC LAB, LARGE (Z0016) 3.20.17

DENTAL CLINIC

FLOOR/EQUIPMENT PLAN 13.01 NSM (140 NSF)

DATE: 04/24/2006

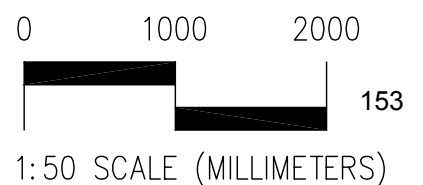

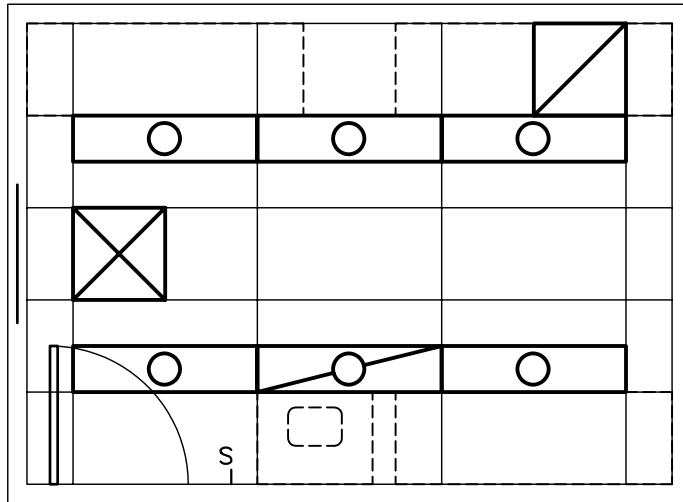

**PORCELAIN ROOM, DENTAL PROSTHODONTIC
LAB, LARGE (Z0016) 3.20.17**

DENTAL CLINIC

REFLECTED CEILING PLAN

DATE: 04/24/2006

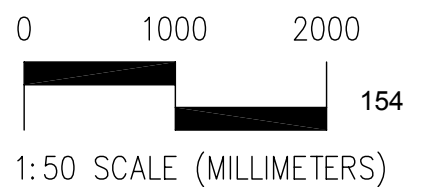

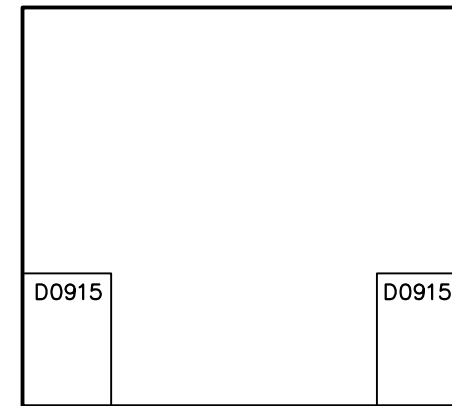

EAST

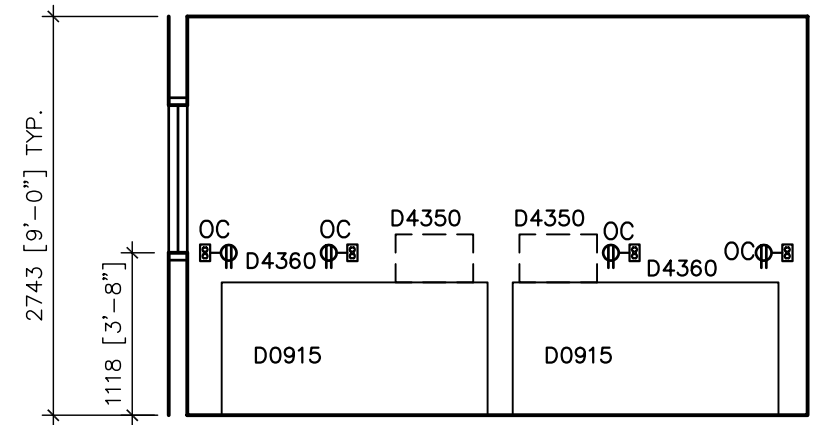

NORTH

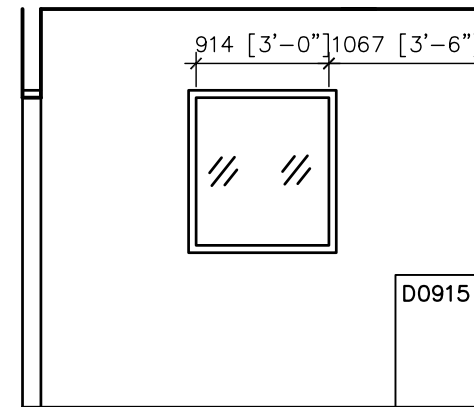

WEST

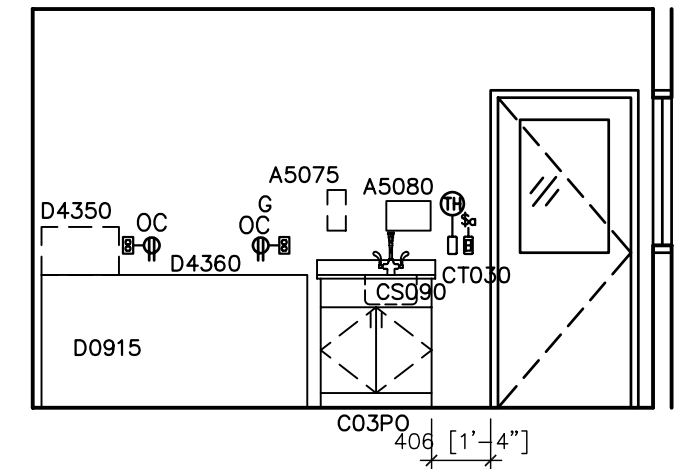

SOUTH

**PORCELAIN ROOM, DENTAL PROSTHODONTIC
LAB, LARGE (Z0016) 3.20.17**

DENTAL CLINIC

ELEVATIONS

DATE: 04/24/2006

0 1000 2000



1:50 SCALE (MILLIMETERS)

Medical Equipment Room Guide Plates

3.20 Dental Unit

Plate Number 3.20.17

Room Name: Porcelain Room, Dental Prosthodontic Lab, Large

SEPS# Z0016

JSN	Nomenclature	Qty	Army Cat	Navy Cat	AF Cat	Utilities					
						1	2	3	4	5	6
A5075	Dispenser, Soap, Disposable	1	C	C	C
A5080	Dispenser, Paper Towel, SS, Surface Mounted	1	A	A	A
CT030	Countertop, High Pressure Laminate	1	A	A	A
D0810	Sink, SS, 10x14x10	1	A	A	A	D
D0915	Workstation, Dental Lab, Ceramic, Modular	3	A	A	A	.	A	D	.	A	.
D3295	Chair, Rotary, Laboratory, Dental	3	C	C	C
D4350	Oven, Curing, Dental	3	C	C	C	.	A
D4360	Pump, Vacuum, Dental Oven	3	C	C	C	.	A
C03F0	Cabinet, U/C/B, 1 Shelf, 2 Half DR, 2 DO, 36x30x22	1	A	A	A
CS090	Sink, SS, Single Compartment, 7.5x19x16 ID	1	A	A	A	D

April 24, 2006